



Operating Manual

V1.0

# Tube Series | Thermal Imaging Scope

TH35/TH50



IRay Technology Co., Ltd.

Add: 11th Guiyang Street, YEDA, Yantai, P.R. China

Tel: 0086-400-998-3088

Email: [infiRayoutdoor@infiRay.com](mailto:infiRayoutdoor@infiRay.com)

Web: [www.infiRayoutdoor.com](http://www.infiRayoutdoor.com)



# IMPORTANT SAFETY INFORMATION

## Environmental influences

**WARNING!** Never point the lens of the device directly at intense heat sources such as the sun or laser equipment. The objective lens and eyepiece can function as a burning glass and damage the interior components. The warranty does not cover damage caused by improper operation.

## Risk of swallowing

**Caution:** Do not place this device in the hands of small children. Incorrect handling can cause small parts to come loose which may be swallowed.

## Safety instructions for use

- Handle the device and battery pack with care: rough handling may damage the battery pack.
- Do not expose the device to fire or high temperatures.
- Only use the battery charger included in the delivery package.
- The battery capacity decreases when operated in a cold ambient temperature. This is not a fault and occurs for technical reasons.
- Always store the device in its carrying bag in a dry, well-ventilated space. For prolonged storage, remove the batteries.
- Do not expose your device to extreme temperatures lower than - 20°C and higher than + 50°C.
- The product shall only be connected to a USB Type C interface.

- If the device has been damaged or the battery is defective, send the device to our after-sales service for repair.

## Safety instructions for the power supply unit

- Check the power supply unit, cable and adapter for visible damage before use.
- Do not use any defective parts. Defective components must be replaced.
- Do not use the power supply unit in wet or humid environments.
- Only use the original cable provided with the battery charger.
- Do not make any technical modifications.

For further information and safety instructions, please refer to the Operation Instructions provided. This is also available on our website in the download center: [www.infirayoutdoor.com](http://www.infirayoutdoor.com).

## User information on the disposal of electrical and electronic devices (private households)

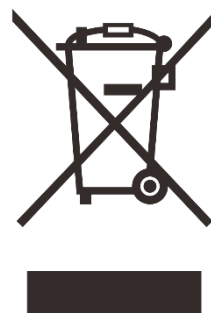

The WEEE symbol on products and/or accompanying documents indicates that used electrical and electronic products must not be mixed with ordinary household waste. For proper treatment, recovery and recycling, take these products to the appropriate collection points where they will be accepted without charge. In some countries, it may also be possible to return these products to your local retailer when you

purchase a corresponding new product. The proper disposal of this product serves to protect the environment and prevents possible harmful effects on human beings and their surroundings, which may arise as a result of incorrect handling of waste.

More detailed information on your nearest collection point is available from your local authority. In accordance with state legislation, penalties may be imposed for the improper disposal of this type of waste.

### **For business customers within the European Union**

Please contact your dealer or supplier regarding the disposal of electrical and electronic devices. He will provide you with further information.

### **Information on disposal in other countries outside of the European Union**

This symbol is only applicable in the European Union. Please contact your local authority or dealer if you wish to dispose of this product and ask for a disposal option.

### **Intended use**

The device is intended for displaying heat signatures during nature observation, remote hunting observations and for civil use. This device is not a toy for children.

Use the device only as described in this instruction manual. The manufacturer and the dealer accept no liability for damages which arise due to non-intended or incorrect use.

### **Function test**

- Before use, please ensure that your device has no visible damage.
  - Test to see if the device displays a clear, undisturbed image.
  - Check that the settings for the thermal imaging riflescope are correct.
- See the notes in the section Operation.

### **Installing/removing the battery**

The Tube series thermal imaging riflescope is equipped with two power supply systems – one built-in battery pack and one replaceable 18500 battery. The built-in battery pack cannot be removed.

### **Observation with and without glasses**

Thanks to the flexible eyeshade, the Tube series can be used with or without glasses. It offers a full field of view in both cases.

# 1 Specifications

Model	TH35	TH50
<b>Detector Specifications</b>		
Type	Uncooled Vox	
Resolution	640×512	
Pixel size, μm	12	
NETD, mk	≤40	
Frame rate, Hz	50	
<b>Optical Specifications</b>		
Objective Lens, mm	35	50
FOV, °	12.5×10.0	8.8×7.0
Optical Magnification, ×	2.5~10	3.5~14
Digital Zoom, ×	1.0~4.0	
Eye Relief, mm	50	
Diopter	-5~+3.5	
Detection Range, m (Target size: 1.7m×0.5m, P(n)=99%)	1816	2361
<b>Display Specifications</b>		
Type	OLED	
Dimensions	1.03"	
Resolution	2560×2560	

<b>Battery Power Supply</b>		
Battery Type	Two built-in 18650 batteries + one replaceable 18500 battery	
Operating time (22 °C), h*	10	
External Power Supply	5V (Type C)	
<b>Physical Specifications</b>		
Scope Diameter, mm	30	
Max. Recoil Power, g/s <sup>2</sup>	1000	
Ingress Protection Rating	IP67	
Memory Capacity, GB	32	
Operating Temperature, °C	-20~+50	
Weight (Without the 18500 Battery), g	<910	<940
Dimension, mm	365×85×75	370×85×75

- ★ Actual operation time depends on the density of Wi-Fi use and video recording functions.
- Improvements may be made to the design and software of this product to enhance its features without prior notice.
- The current version of the User Manual is available on our official website: [www.infirayoutdoor.com](http://www.infirayoutdoor.com).

## 2 Package Contents

- Tube Series Thermal Imaging Riflescope
- Eyeshade
- Mounting for Picatinny rail
- IPB-3 portable bag
- USB-C cable
- Power adapter
- Lens cleaning cloth
- Heated target for zeroing

## 3 Description

Tube Series Thermal Imaging Riflescopes are infrared scopes for outdoor hunting. Designed based on infrared thermal imaging principles, they require no external light sources during the day and at night, in all hard weather conditions (such as rain, snow, fog, and haze). They can be used without being affected by strong light and to observe even targets behind obstacles (such as branches, grass, and shrubs). The Tube series has a variety of battery-powered solutions with long operating hours, and can

be widely used for hunting, observation and positioning in low visibility conditions. It adopts a 30mm standard pipe diameter to meet the requirements of the general clamp interface.

## 4 Product Features

- 12 $\mu$ m self-developed detector
- High image quality
- Infinite zoom
- Dual power supply system, with long battery life
- Standard 30mm pipe diameter
- Stadiametric rangefinder
- Long detection distance
- 50Hz frame rate
- Built-in memory card, supporting photo taking and video recording
- Built-in Wi-Fi module, supporting app connection
- Built-in digital magnetic compass and gravity sensor
- PIP (picture-in-picture) function
- Defective pixel calibration
- Automatic image correction



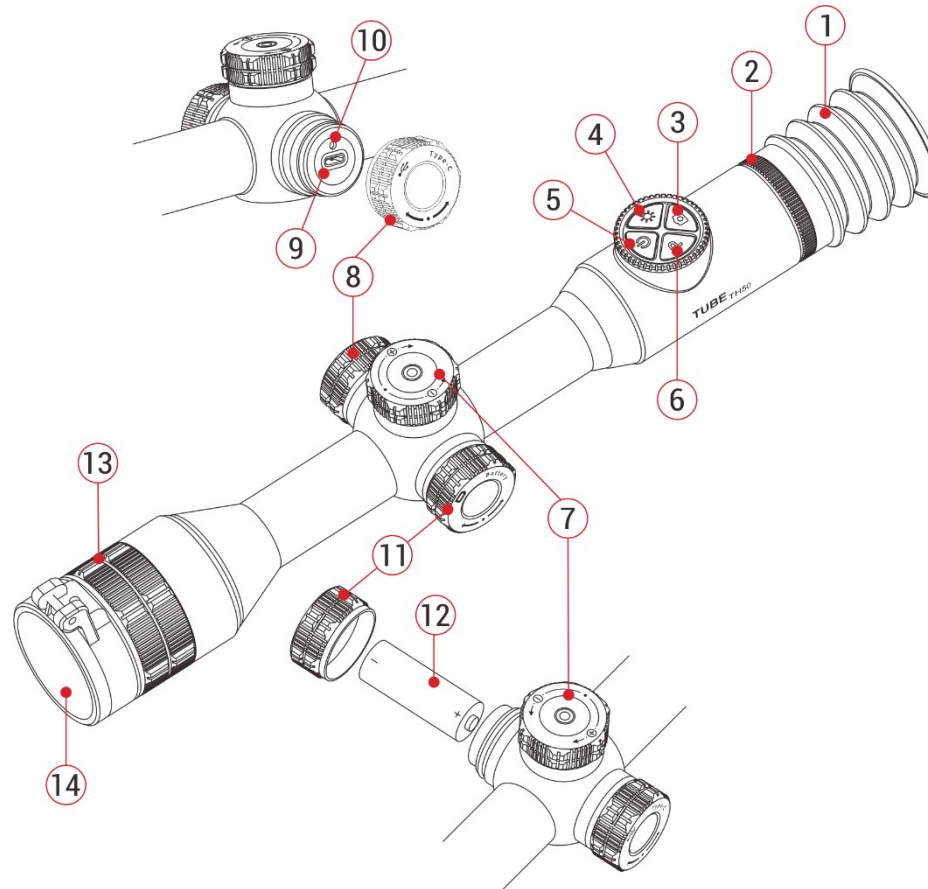

- Two image hue for selection: Cold and warm

## 5 Components and Controls

1. Eyeshade
2. Diopter adjustment ring
3. Camera button
4. Brightness button
5. Power button
6. Palette button
7. Rotary encoder
8. USB cover
9. Type-C port
10. LED indicator
11. Extend battery cover
12. 18500 battery
13. Lens focus ring
14. Lens cover



## 6 Button Description

Button	Current Status	Press	Press and Hold	Rotate
<b>Power button</b> 	Powered off	—	Power on the device	—
	Home screen	Calibrate the image	Power off the device/Standby	—
	Standby	Wake up the device	—	—
	Main menu interface	Return to the upper menu without saving changes	—	—
	Pixel defect correction interface	Add/delete pixel defects	—	—
<b>Palette button</b> 	Home screen	Switch image modes	Turn on/off the PIP function	—
<b>Brightness button</b> 	Home screen	Adjust the display brightness	Turn on/off the stadiametric rangefinder function	—
<b>Camera button</b> 	Home screen	Photographing	Start/Stop video recording	—

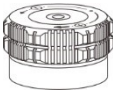
<p><b>Palette + Brightness button</b></p>	<p>Home screen</p>	<p>—</p>	<p>Enable/Disable the reticle and its functions</p>	<p>—</p>
<p><b>Palette + Camera buttons</b></p>	<p>Zeroing interface</p>	<p>—</p>	<p>Picture Freezing</p>	<p>—</p>
<p><b>Brightness + Camera buttons</b></p>	<p>Zeroing screen</p>	<p>—</p>	<p>Return reticle to the center</p>	<p>—</p>
<p><b>Rotary encoder</b></p> 	<p>Home screen</p>	<p>Open the shortcut menu</p>	<p>Open the main menu</p>	<p>Adjust image magnification</p>
	<p>Shortcut menu interface</p>	<p>Adjust specific parameters of a function</p>	<p>Save and back to the home screen</p>	<p>Switch menu options / move reticle position:  <b>Clockwise:</b> move to the left/down direction;  <b>Anticlockwise:</b> move to the right/up direction</p>
	<p>Main menu interface</p>	<p>Confirm the option parameters/Open the submenu</p>	<p>Save and back to the main menu interface</p>	
	<p>Pixel defect correction interface / zeroing interface</p>	<p>Switch between the X axis/Y axis</p>	<p>Save and back to the main menu</p>	



## 7 Power Supply

The Tube series adopts a dual power system (built-in chargeable Lithium-ion battery pack and a replaceable 18500 battery). The normal working time of the dual power supply system can be up to 10 hours. Also, Tube series can support the USB power supply.

Please notice that the battery should be fully charged before first use.

### Charging the Built-in Battery

During use, if the built-in battery icon turns into , it indicates that the battery level is low. Please charge the battery in time to avoid reducing the service life of the device due to over discharge of the battery.

- Rotate the USB cover (8) counterclockwise and remove it.
- connect the Type-C end of the attached data cable (15) to the Type-C port (9) on the Tube series.

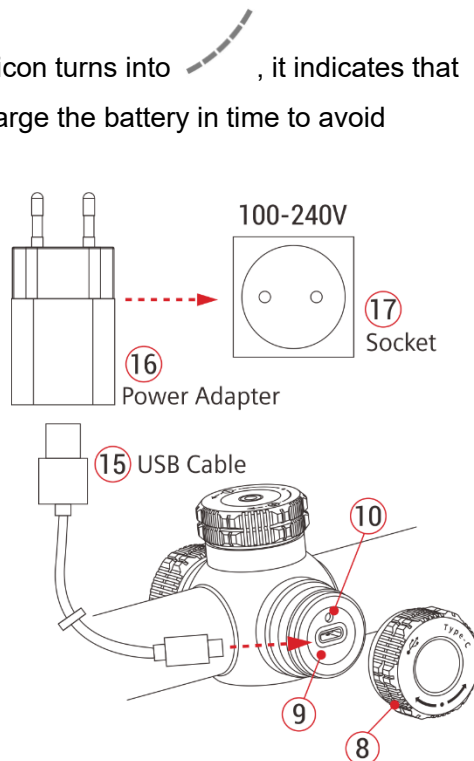

- Connect the other end of the data cable (15) to the USB port on the power adapter (16). Plug the adapter (16) into a 100-240V power socket (17) for charging.
- During charging, a charging icon  appears on the right of the battery icon, and the LED indicator on the device is red. When the indicator turns green, it indicates that charging is complete.

**Note:** The USB port can only be used for charging the built-in battery pack.

### Installing 18500 battery

- Turn the battery cover (11) counterclockwise and remove it.
- Install the 18500 battery (12) into the battery compartment along the special label in the battery compartment designed for it, that is, the positive pole faces inward and the negative pole faces outward.
- Close and tighten the battery cover (11) by turning it clockwise.

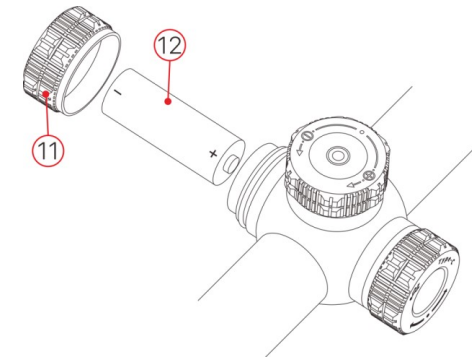

### Switching between the two batteries

- If both batteries are installed in the Tube device, two battery icons are displayed on the right of the status bar below the image, with the replaceable battery icon on the left and the built-in battery icon on the right. The battery from which the device is powered is displayed in green, inactive - in gray.

- If there is no replaceable battery in the device, only the green icon of the built-in battery is displayed on the right.

- If the both batteries are fully charged, the replaceable battery will be preferred to power the device. If the replaceable battery level is low, the device will switch to the built-in battery automatically.

- When connecting to the external power supply using the USB port (9), it will switch to the external power supply automatically. At this time, a lightning charging icon  is displayed above the built-in battery icon on the right of the display, which indicates that the built-in battery is being charged.

- When the device is in use, it is possible to change the replaceable



battery without powered on. At this time, it will switch to the internal battery automatically.

## Safety Measures

- When charging, always use the 5V2A power adapter compatible with the device. Using any other type of adapter may cause irreversible damage to the battery or the adapter itself.
- If the device is not in use for a long time, the battery should be partially charged, not fully charged or discharged.
- Do not charge the device immediately after it is moved to a warm environment from a cold environment. Wait for 30 to 40 minutes for preheating.
- If the charger is modified or damaged, do not use it.
- The device should be charged at a temperature of 0°C to +40°C. Otherwise, the battery life will be significantly reduced.
- When charging, please do not leave the battery unattended.
- Do not connect the battery to the power supply for more than 24 hours after it is already fully charged.
- It is not recommended to connect third-party devices that consume more energy than the allowed value.
- The device is equipped with a short circuit protection system, but

conditions that may lead to a short circuit should be avoided.

- The recommended operating temperature for the device is  $-20^{\circ}\text{C}$  to  $+50^{\circ}\text{C}$ . Do not use the device beyond this temperature range, or else, it may shorten the battery life.
- When using the device at low temperatures, the battery capacity decreases. This is normal and not a defect.
- Do not use the device at the temperatures above  $50^{\circ}\text{C}$  – this may decrease the battery's life.
- Keep the battery out of the reach of children.

## 8 External Power Supply

The Tube series supports external power supplies, such as the portable power source for a mobile phone (5V).

- Connect an external power supply to the USB port (9) of the Tube device.
- Then, the device automatically switches to the external power supply and charge the internal battery pack at the same time. At the same time, a lightning charging icon  is displayed above the built-in battery icon on the right of the display, which indicates that the built-in

battery is being charged.

- When the external power supply is turned off, the device switches to the replaceable 18500 battery for power supply. If no replaceable 18500 battery is installed or the battery level is low, it will switch to the built-in battery pack, instead of shutdown.



## 9 Installation of Rifle Mount

To ensure firing accuracy, please fix the Tube at a proper position on the weapon.

- The Tube series is fixed using the mount provided in the package. The Tube series adopts a tubular body design with a diameter of 30mm, which is compatible with standard mounts of day scopes with a diameter of 30mm. Proper tools can be used to install the Tube series according to the supplier's installation suggestions and steps.
- When mounting the riflescope, adjust the position on the weapon so

that proper (comfortable) holding of weapon ensures the distance between the riflescope and eye (eye relief) specified by the **Technical Specifications**. Failure to comply with this recommendation may result in injury to the shooter by the parts of the riflescope eyepiece when shooting.

- It is recommended to install the riflescope as low as possible, at the same time it should be away from the barrel or other devices.
- Use the supplied torque wrench to tighten the screws of the mounting rings but avoid pinching the riflescope body.
- Before using the riflescope for hunting, please follow the instructions in the **Zeroing** section to zero the device first.
- It is recommended to use an eyecup while using the riflescope in the dark in order to avoid detection of camouflage. Mounting the eyecup on the riflescope eyepiece is carried out through the thread.

## 10 Operation

- Open the lens cover **(14)**.
- Press and hold the power button **(5)** for 2s to power on the device.
- Rotate the lens focus ring **(13)** to focus on the object being observed.

- Adjust the resolution of the icons on the display by rotating the diopter adjustment ring **(2)** on the eyepiece.
- **Setting the image mode:** On the home screen, press the palette button **(6)** to set the image palette mode: white hot, black hot, pseudo-color, red hot, and highlight, in sequence. The icon on the top status bar is updated in real-time.
- **Setting the display brightness:** On the home screen, press the brightness button **(4)** to set the display brightness level from level 1 to level 5. Meanwhile, a short prompt for the corresponding brightness icon appears on the left side of the display.
- **Setting the image sharpness:** Press the rotary encoder **(7)** to go to the shortcut menu, and set the image sharpness (refer to Chapter "Shortcut Menu" for details).
- **Power off:** After using the device, press and hold the power button **(5)** for 3 seconds to enter the power-off interface with a shutdown countdown. Release the button when the countdown icon turns to 0, then



a prompt interface "Data saving ..." is displayed. When the data is saved, the display turns black and the device is off.

**During the saving data, do not disconnect it from the power source, otherwise, the data cannot be saved.**

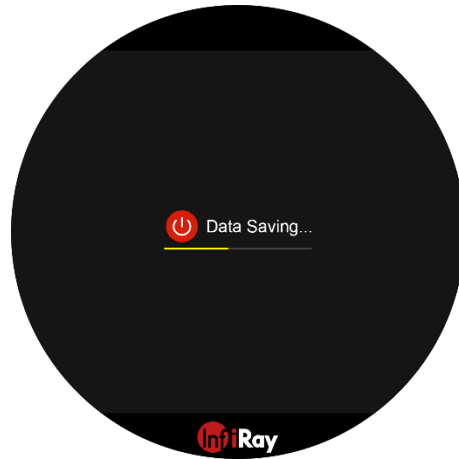

- **Standby:** On the power-off interface, release the power button (5) before the countdown turns to 0 to standby the device. To wake up the device, press the power button (5) again.

## 11 Zeroing

The Tube series uses the "freeze" zeroing method. It is recommended to perform zeroing in environments within the operating temperature range of the scope.

- Fix the riflescope with the mount ring on your weapon. For details, refer to the section **Installation**.
- When using the scope for the first time, press and hold the brightness

button (4) and the Palette button (6) at the same time for more than 15s to enable reticle and zeroing functions.

- Select a target at a certain distance, such as 100m, 200m, etc.
- Adjust the scope according to the operating instructions as described in the section **Power on and Image Setting**.
- Select the zeroing profile (refer to **Reticle Setup - Zeroing Profile** in the Main Menu function).
- Press and hold the rotary encoder (7) to enter the main menu screen, select the zeroing option, and press the rotary encoder (7) to enter the submenu of the zeroing function (refer to **Main menu – Zeroing**).
- According to the selected target distance, select or add the new zeroing distance (refer to **Zeroing - Zeroing Distance - Set Zeroing Distance** in the main menu).
- When the zeroing distance is set up, rotate the encoder (7) to select the zeroing function, and press the encoder (7) to enter the zeroing screen (refer to **Zeroing - Zeroing Distance - Zeroing** in the main menu). The coordinate positions of the reticle (X axis and Y axis) are displayed in the lower middle of the display.
- Point the weapon at the center of the target and shoot.
- Observe the position of the actual point of impact, and assume that

the red mark × in the figure on the right is the position of the point of impact (This mark is only for illustration. It should actually be a bullet hole).

- If the impact point does not match with the aiming point (the center of the riflescope reticle), keep the aiming position still, and meanwhile, press and hold the power button (6) and the camera button (3) to freeze the picture, and then a snow-like freezing icon ❄️ appears in the lower middle of the display.

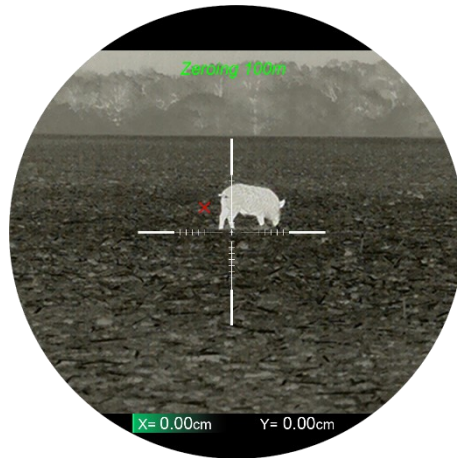

- Turn the rotary encoder (7) to move the reticle, rotate clockwise to move the cursor left or downward, and rotate anticlockwise to move the cursor right or upward.
- Press the rotary encoder (7) to switch between the X axis and Y axis, and the position of the shade indicates the currently selected item.

- After moving the reticle, a little white dot appears on the display, indicating the position of the reticle before moving.
- When the reticle overlaps the actual point of impact, press and hold the rotary encoder (7) to save the current reticle position and return to the main menu.
- Repeat aiming and shooting, until the position of the point of impact is consistent with that of the aiming point.
- Press and hold the Brightness Adjustment button and Camera button simultaneously for 3s to return the reticle center to the position (0,0).

## 12 Calibration

When the image is degraded or uneven, it can be improved by calibration.

Calibration can balance the background temperature of the detector and eliminate the defects in the image.

There are two calibration modes: automatic calibration and manual shutter calibration.

- **Automatic calibration:** When the image is degraded or uneven, the device conducts automatic shutter calibration through software algorithms.



- **Manual shutter calibration:** On the home screen, press the power button **(5)** for manual shutter calibration with the lens cover removed (the sensor automatically closes the internal shutter).

## 13 Digital Zoom

The Tube series Scope supports the continuously variable zoom function of 3.5-14.0 (TH35: 2.5-10), by which you can magnify an image by 1 to 4 times.

- On the home screen, turn the rotary encoder **(7)** to zoom in/out the image.
- Zoom in by rotating clockwise, and zoom out by rotating anticlockwise.
- The magnification is displayed at the bottom of the display area in real time.
- Each time you rotate the rotary encoder, the image is zoomed in or out by 0.35 (TH35: 0.25) times.

## 14 Photographing and Video Recording

The Tube series is equipped with a built-in 32GB memory space, which

allows photographing and video recording. Please download the APP operation manual from our official website for detailed operation steps.

### Photographing

- On the home screen, press the camera button **(3)** to take a photo. A photo icon appears in the upper left corner of the display after the picture is stuck for 0.5s.
- The images taken are saved in the built-in memory space.



### Video Recording

- On the home screen, press and hold the camera button **(3)** to start the video recording.
- A prompt box showing the recording time appears in the upper right corner of the

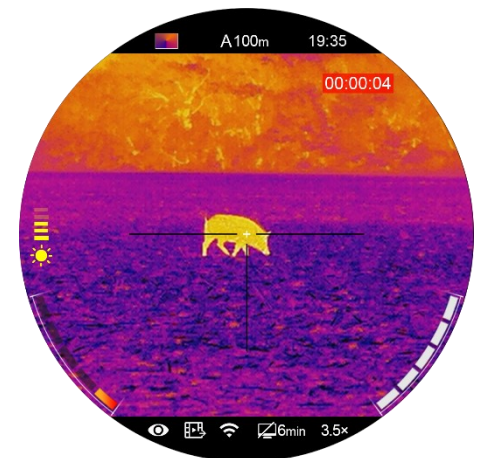

display, with the time format as 00:00:00 (hours: minutes: seconds).

- During recording, you can also take a photo by pressing the camera button **(3)**.
- Stop the recording and save the video by pressing and holding the camera button **(3)**.
- The videos and images taken are saved in the built-in memory space.



## Note

- The menu can still be operated during video recording.
- The images and the videos are stored in the built-in memory card in the format of IMG\_HHMMSS\_XXX.jpg (for images) and VID\_HHMMSS.mp4 (for videos). HHMMSS - hours/minutes/seconds, XXX - three-digit common counter for photos which is NOT reset.
- If a file is deleted from the list, its number is not taken by the other file.
- The number of files is limited by the capacity of the built-in memory space of the device. It is suggested to check the available space of the memory card regularly and transfer your videos and images to other media to free up the space on the memory card.
- The reticle is displayed on the captured videos/images, but GUI icons are not.

## Memory Access

When the device is powered on and connected to a computer, it will be recognized by the computer as a flash memory card. Then, you can access the memory of the device and copy images and videos.

- Connect the device to a computer through the data cable.
- Power on the device.
- Double click "My Computer" on the desktop of your computer - double

click to open the device named "Infiray"  - double click to open the device name "Internal Storage"  28.8GB available 28.8 GB total to access the built-in memory.

- There are different folders named by time in the format of xxxx (year) xx (month) xx (day)  20191218 .
- Recorded photos and videos in that day are saved in the folders
- Select desired files or folders to copy or delete.





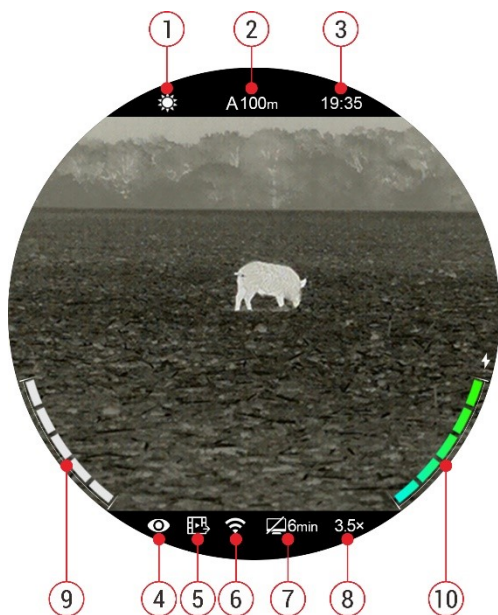

## 15 Status Bar



The status bar shows information about the device's current operations.

In sequence, this includes:

1. Current image mode (  : white-hot;  : black-hot;  : red-hot;  : highlight;  : pseudo-color;)
2. Current zeroing profile and zeroing distance (e.g., A100m)
3. Clock (Set it in the main menu or synchronize the time in App)
4. Ultra-clear mode status (Displayed when the ultra-clear mode is on)
5. Video output status (Displayed when the video output is on)
6. Wi-Fi (Displayed when the Wi-Fi is on)

7. Standby status and time (Off is default)

8. Current optical magnification (e.g., 3.5×)

9. The power status of the replaceable battery (when 18500 battery is installed)

10. The power status of the built-in battery pack

**Note:** Colored battery icon indicates that the battery is supplying power.





The levels show the remaining battery life. When the remaining battery is low, please charge it in time. The display of a lightning icon on the right of the battery signifies that an external power supply is working and charging the built-in battery pack.

## 16 Shortcut Menu

The shortcut menu can be used for a quick setup of the basic settings of some common functions, including reticle style, reticle color, image sharpness, and zeroing distance. Press and hold the rotary encoder **(7)** to save the operation and return to the home screen.

- On the home screen, press the rotary encoder **(7)** to enter the shortcut menu interface.
- Rotate the rotary encoder **(7)** to switch between the following function

options, and the icon background of the selected option will be highlighted:

- **Reticle Style** : Rotate the rotary encoder (7) to select the reticle style, and press the rotary encoder (7) to switch between 6 styles.
- **Reticle Color** : Rotate the rotary encoder (7) to select the option, and press the rotary encoder (7) to adjust the colors in the sequence of white, black, red and green.
- **Image Sharpness** : Rotate the rotary encoder (7) to select the option, and press the rotary encoder (7) to adjust the image sharpness from level 1 to 5.
- **Zeroing Distance** : Rotate the rotary encoder (7) to select the option, and press the rotary encoder (7) to switch between the distance values saved for the current zeroing type (e.g., For firearm type A, when you select the option, only the distance values saved for type A will be available).
- It is worth noting that it will automatically save the changes and return to the home screen from the shortcut menu, if there is no operation within 5s.

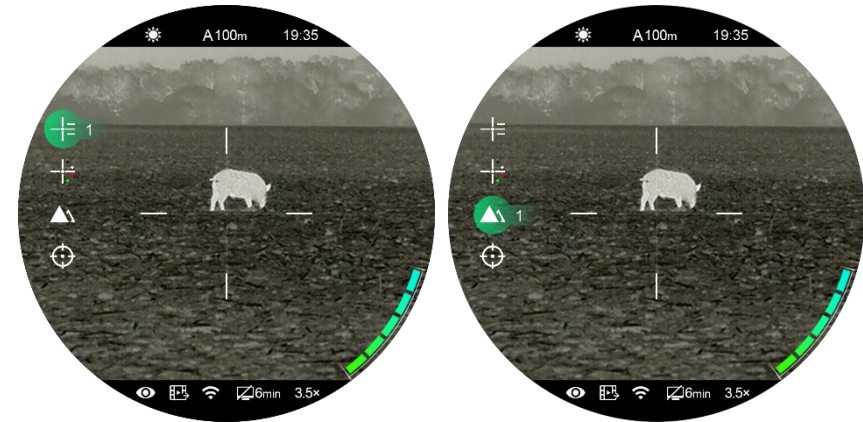

## 17 Main Menu



- On the home screen, press and hold the rotary encoder (7) for 3s to go to the main menu.
- Rotate the rotary encoder (7) to switch between the function options in the main menu, rotate clockwise to move down and anticlockwise to move up.
- Press the rotary encoder (7) to modify the parameters of the current option or enter the submenu.
- The selected option's icon turns green from white.
- The operation of secondary and tertiary menus is the same as above.
- In any menu screen, press and hold the rotary encoder (7) to save the





changes and return to the home screen.





- In any menu screen, the device will automatically return to the home screen without saving the changes with a short press of the power button **(5)** or when there is no operation within 15s.
- During the continuous operation of the scope, when exiting from the main menu, the selected option remains at the position before exiting. When you restart the scope and enter the main menu for the first time, the selected option stays at the first menu option.

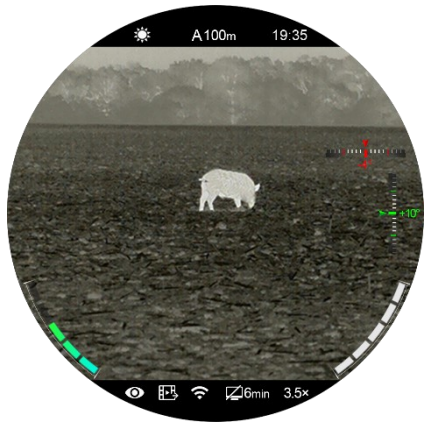

### Main Menu Features and Descriptions

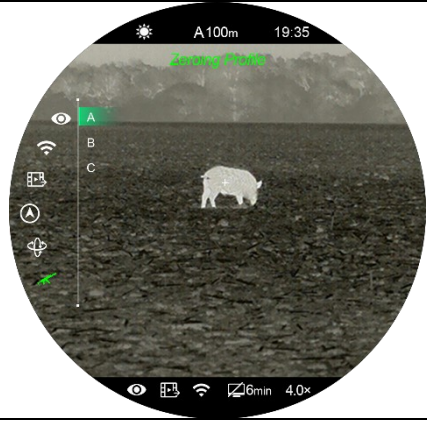
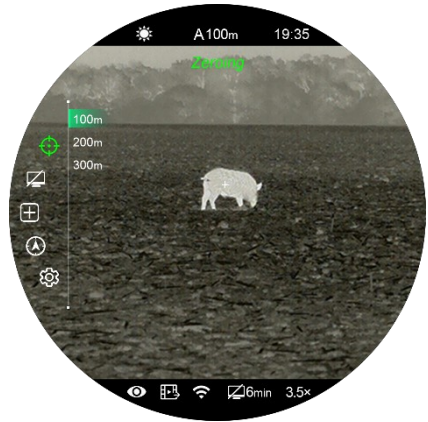

<p><b>Ultraclear Mode</b></p> 	<p><b>Turn the Ultraclear mode on/off</b></p> <ul style="list-style-type: none"> <li>● Press and hold the rotary encoder <b>(7)</b> to enter the main menu.</li> <li>● Rotate the rotary encoder <b>(7)</b> to select the <b>Ultraclear Mode</b> option (selected by default on the menu after start up).</li> <li>● Press the rotary encoder <b>(7)</b> to turn the Ultraclear mode on/off, along with the sound of shutter calibration.</li> <li>● When the Ultraclear mode is on, the Ultra-clear Mode icon is displayed in the status bar at the bottom.</li> </ul>
<p><b>Wi-Fi</b></p> 	<p><b>Turn the Wi-Fi function on/off</b></p> <ul style="list-style-type: none"> <li>● Press and hold the rotary encoder <b>(7)</b> to enter the main menu.</li> <li>● Rotate the rotary encoder <b>(7)</b> to select the <b>Wi-Fi</b> function option.</li> <li>● Press the rotary encoder <b>(7)</b> to turn Wi-Fi function on/off.</li> <li>● When the Wi-Fi is on, the Wi-Fi icon is displayed in the status bar at the bottom.</li> </ul>

<p><b>Video Output</b></p> 	<p><b>Turn the video output on/off</b></p> <ul style="list-style-type: none"> <li>● Press and hold the rotary encoder (7) to enter the main menu.</li> <li>● Rotate the rotary encoder (7) to select the <b>Video Output</b> option.</li> <li>● Press the rotary encoder (7) to turn the analog video output function on/off.</li> <li>● When the video output is on, the video output icon is displayed in the status bar at the bottom.</li> </ul>	
<p><b>Digital Compass</b></p> 	<p><b>Turn on/off the digital compass function</b></p> <ul style="list-style-type: none"> <li>● Press and hold the rotary encoder (7) to enter the main menu.</li> <li>● Rotate the rotary encoder (7) to select the <b>Digital Compass</b> option.</li> <li>● Press the rotary encoder (7) to turn the digital compass on/off.</li> <li>● When the digital compass function is on, it will be displayed at the top of the screen.</li> </ul>	
<p><b>Gravity Sensor</b></p> 	<p><b>Turn on/off the gravity sensor</b></p> <ul style="list-style-type: none"> <li>● Press and hold the rotary encoder (7) to enter the main menu.</li> <li>● Rotate the rotary encoder (7) to select the <b>Gravity Sensor</b> option.</li> <li>● Press the rotary encoder (7) to turn the gravity sensor on/off.</li> <li>● When the gravity sensor is on, its functions will be displayed on the right of the screen.</li> <li>● The upper curved scale represents the tilt angle and the vertical one on the right represents the pitch angle.</li> </ul>	
<p><b>Zeroing Profile</b></p>	<p><b>Select Zeroing Profile</b></p>	

	<ul style="list-style-type: none"> <li>● Press and hold the rotary encoder (7) to enter the main menu.</li> <li>● Rotate the rotary encoder (7) to select the <b>Zeroing Profile</b> option.</li> <li>● Press the rotary encoder (7) to enter the submenu of the zeroing profile.</li> <li>● Rotate the rotary encoder (7) to select one from the three zeroing profiles (A, B, C).</li> <li>● Press the rotary encoder (7) to confirm the selection, and return to the main menu.</li> <li>● The name of the selected profile appears in the status bar.</li> </ul>	 <p>A circular screenshot of the device's interface showing the 'Zeroing Profile' menu. The status bar at the top displays 'A 100m' and '19:35'. The main screen shows a white pig in a field with a vertical menu on the left containing options 'A', 'B', and 'C'. The bottom status bar shows various icons and '6min 4.0x'.</p>	
<p><b>Zeroing</b></p>	<p>Please set up the zeroing profile and zeroing distance before carrying out any zeroing operation.</p> <p>The Tube series supports any zeroing distance between 1 and 999 meters.</p> <ul style="list-style-type: none"> <li>● Press and hold the rotary encoder (7) to enter the main menu.</li> <li>● Rotate the rotary encoder (7) to select the <b>Zeroing</b> option.</li> <li>● Press the rotary encoder (7) to enter the submenu of Zeroing, where displays the zeroing distance.</li> <li>● Rotate the rotary encoder (7) to select the zeroing distance based on the preset target distance. The default values are 100m, 200m, 300m.</li> <li>● Press the rotary encoder (7) to confirm the zeroing distance, and enter the zeroing distance submenu as follows.</li> </ul>	 <p>A circular screenshot of the device's interface showing the 'Zeroing' submenu. The status bar at the top displays 'A 100m' and '19:35'. The main screen shows a white pig in a field with a vertical menu on the left containing options '100m', '200m', and '300m'. The bottom status bar shows various icons and '6min 3.5x'.</p>	
	<p><b>Zeroing</b></p>		<p>If the default zeroing distance is consistent with the preset target distance, you can zero your device directly as follows.</p> <ul style="list-style-type: none"> <li>● Select the <b>Zeroing</b>  option and briefly press the rotary encoder (7) to enter the <b>Zeroing</b> interface.</li> <li>● The X axis and Y axis coordinates of the reticle are displayed at the bottom of the screen.</li> </ul>

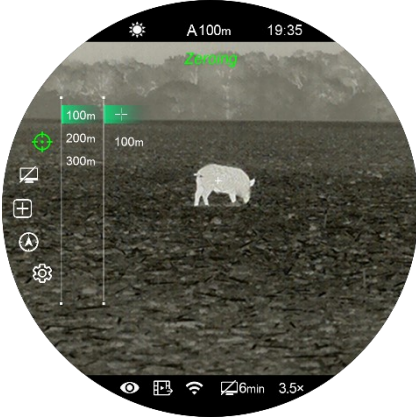
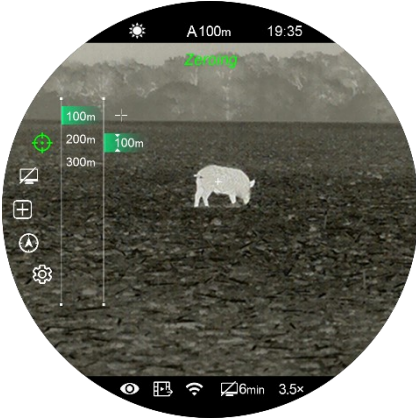

	<ul style="list-style-type: none"> <li>● Aim the reticle center at the target and shoot, and then observe the position of the actual point of impact.</li> <li>● If the impact point is not the same as the aim point, keep the aiming position still, and press and hold the <b>Palette (6) + Camera (3)</b> buttons at the same time to freeze the picture, and the freezing icon ❄️ appears on the bottom center of the screen.</li> <li>● Rotate the rotary encoder (7) to move the reticle position, until the reticle center aims at the position of the point of impact. For details, refer to section <b>Zeroing</b>.</li> </ul>	
<p><b>Setting the Zeroing Distance</b></p> <p>▼ 000 ▲</p>	<p>If the default zeroing distance is not consistent with the preset target distance, you can set the distance here.</p> <ul style="list-style-type: none"> <li>● Select a <b>non-primary distance</b> and enter the submenu for operation with a brief press of the encoder (7).</li> <li>● Rotate the rotary encoder (7) to select the option "<b>Setting the Zeroing Distance</b>".</li> <li>● Press the rotary encoder (7) to activate the zeroing distance reset function, and then two small triangle symbols are displayed above and below the number 0.</li> <li>● Rotate the rotary encoder (7) to set the number value of the current position from 0 to 9.</li> <li>● Press the rotary encoder (7) to switch among the positions of hundred, ten and one digits.</li> </ul>	





	<ul style="list-style-type: none"> <li>● After setting, press and hold the encoder (7) to save the setting and exit. The cursor returns to the zeroing option, and the zeroing distance changes accordingly.</li> <li>● Besides, the status bar updates to the new zeroing distance synchronously.</li> </ul>
<p><b>Standby Settings</b></p> 	<p><b>Setting standby status and time</b></p> <ul style="list-style-type: none"> <li>● Press and hold the rotary encoder (7) to enter the main menu.</li> <li>● Rotate the rotary encoder (7) to select the <b>Standby Settings</b> option.</li> <li>● Press the rotary encoder (7) briefly to enter the Standby Settings submenu.</li> <li>● Rotate the rotary encoder (7) to select one option from 2min, 4min, 6min and off.</li> <li>● Press the rotary encoder (7) to confirm the selection, and then the selected option is displayed at the bottom status bar.</li> <li>● If Off is selected, the standby function is disabled.</li> </ul> <p><b>Note:</b></p> <ul style="list-style-type: none"> <li>- When the device is in the shooting status (horizontally positioned), the standby mode is disabled.</li> </ul> 
<p><b>Pixel Defect Correction</b></p> 	<p>When using the scope, you may see pixel defects, such as visible light spots or dark spots with stable brightness. To address this problem, use the pixel defect calibration function to remove the pixel defects.</p> <ul style="list-style-type: none"> <li>● Press and hold the rotary encoder (7) to enter the main menu.</li> <li>● Rotate the rotary encoder (7) to select the <b>Pixel Defect Correction</b> option.</li> <li>● Press the rotary encoder (7) to enter the Pixel Defect Correction interface. A small cross cursor appears in the center of the screen and the PIP function is automatically on, which is displayed at the top of the screen by default.</li> <li>● The prompts about the movement direction of the cursor (X axis, Y axis) and number of calibrated pixels are displayed on the</li> </ul>



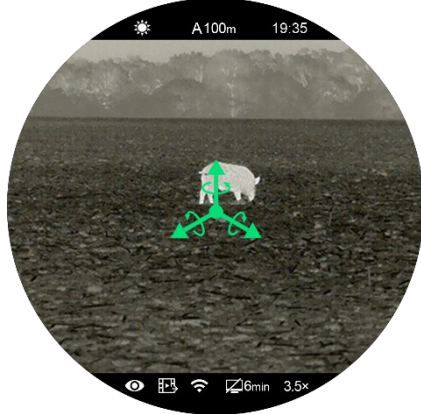

bottom of the screen.





- Press the rotary encoder **(7)** to switch the movement direction between the X axis and the Y axis. The selected direction icon will become green.
- Rotate the rotary encoder **(7)** to move the cursor along the direction selected, rotate clockwise to move the cursor leftward or downward, and rotate anticlockwise to move the cursor rightward or upward.
- Repeat the preceding steps to change the cursor location until the cursor is aligned with the defective pixel. Press the power button **(5)** briefly to add and calibrate the defective pixel and the **Add** message will appear on the PIP window for a short time.
- Repeat the above operations to remove other defective pixels.
- At the same position, you can revoke the pixel defect calibration with a short press of the power button **(5)** again. **Del** is displayed in PIP window.
- Each time you add or delete a pixel defect, the number of pixel defects changes accordingly.
- After calibration, press and hold the rotary encoder **(7)** until a prompt asking whether to save appears on the screen.
- Rotate the rotary encoder **(7)** to select Yes or No to save or not.
- Press the rotary encoder **(7)** to confirm the selection.
- After Yes is selected, the countdown message "Saving...5" appears on the screen. It will exit to the home screen after the prompt **Saving successful** appears.

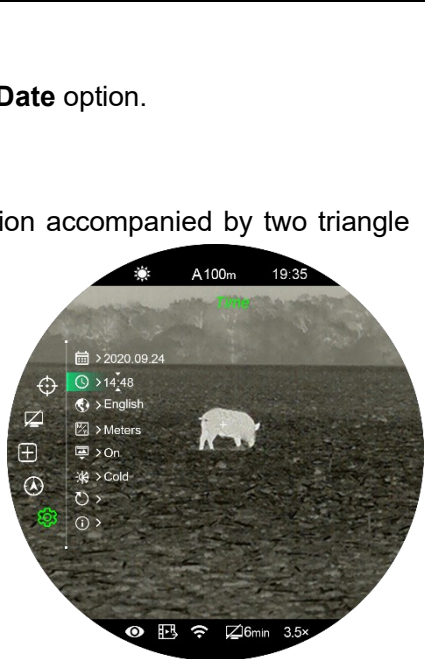









<p style="text-align: center;"><b>Compass Calibration</b></p> 	<p><b>Calibrating the digital compass</b></p> <ul style="list-style-type: none"> <li>● Press and hold the rotary encoder (7) to enter the main menu.</li> <li>● Rotate the rotary encoder (7) to select the <b>Compass Calibration</b> section.</li> <li>● Press the rotary encoder (7) to enter the Compass Calibration interface.</li> <li>● An icon like a triaxial coordinate system appears on the screen.</li> <li>● Rotate the scope following the three axes indicated by the icon, with each axis rotating at least 360° within 15 seconds.</li> <li>● After 15s, the calibration is finished and exit to the home screen.</li> </ul> 	
<p style="text-align: center;"><b>Settings</b></p> 	<p>This function is used to set the date, time, language, measurement unit, status auto hiding, hue Switching, factory reset, and device information query.</p> <ul style="list-style-type: none"> <li>● Press and hold the rotary encoder (7) to enter the main menu.</li> <li>● Rotate the rotary encoder (7) to select the <b>Settings</b> option.</li> <li>● Press the rotary encoder (7) to enter the submenu of the settings. This menu item allows you to configure the following settings.</li> </ul> 	
	<p style="text-align: center;"><b>Date Setting</b></p> 	<p><b>Setting the system date</b></p> <ul style="list-style-type: none"> <li>● In the <b>Settings</b> submenu, rotate the rotary encoder (7) to select the <b>Date</b> option.</li> <li>● Press the rotary encoder (7) briefly to activate the date reset function accompanied by two triangle icons appearing above and below the value.</li> <li>● Date format is displayed as <b>YY.MM.DD</b> format.</li> </ul>

	<ul style="list-style-type: none"> <li>● Rotate the rotary encoder (7) to set the correct year, month and date.</li> <li>● Press the rotary encoder (7) to switch among year, month and date.</li> <li>● After setting, press and hold the rotary encoder (7) to save changes and exit the date setting function.</li> </ul>	
<p style="text-align: center;"><b>Time Setting</b></p> 	<p><b>Setting the system time</b></p> <ul style="list-style-type: none"> <li>● In the <b>Settings</b> submenu, rotate the rotary encoder (7) to select the <b>Date</b> option.</li> <li>● Time format is displayed as <b>HH:MM</b> in 24-hours format (14:48).</li> <li>● Press the rotary encoder (7) briefly to activate the date reset function accompanied by two triangle icons appearing above and below the value.</li> <li>● Rotate the rotary encoder (7) to set the correct hour and minute.</li> <li>● Press the rotary encoder (7) to switch between the hour and minute.</li> <li>● After setting, press and hold the rotary encoder (7) to save changes and exit the time reset function.</li> <li>● After setting time, the time in the status bar changes accordingly.</li> </ul>	
<p style="text-align: center;"><b>Language</b></p> 	<p><b>Selecting the language of the GUI</b></p> <ul style="list-style-type: none"> <li>● In the <b>Settings</b> submenu, rotate the rotary encoder (7) to select the <b>Language</b> option.</li> </ul>	

	<ul style="list-style-type: none"> <li>● Press the rotary encoder <b>(7)</b> to enter the submenu for language selection.</li> <li>● Rotate the rotary encoder <b>(7)</b> to switch among English, German and Russian.</li> <li>● Press the rotary encoder <b>(7)</b> to confirm the selection and return to the upper menu.</li> </ul>	
<p><b>Units of Measure</b></p> 	<p><b>Selecting the units of measure</b></p> <ul style="list-style-type: none"> <li>● In the <b>Settings</b> submenu, rotate the rotary encoder <b>(7)</b> to select the <b>Units of Measure</b> option.</li> <li>● Press the rotary encoder <b>(7)</b> to enter the submenu for unit setup.</li> <li>● Rotate the rotary encoder <b>(7)</b> to switch between meter and yard.</li> <li>● Press the rotary encoder <b>(7)</b> to confirm the selection and exit to the upper menu interface.</li> </ul>	
<p><b>Status Auto Hiding</b></p> 	<p><b>Enabling/Disabling status auto hiding</b></p> <ul style="list-style-type: none"> <li>● In the <b>Settings</b> submenu, rotate the rotary encoder <b>(7)</b> to select the <b>Status Auto Hiding</b> option.</li> <li>● Press the rotary encoder <b>(7)</b> to enter the submenu of the status auto hiding option.</li> <li>● Rotate the rotary encoder <b>(7)</b> to select On or Off.</li> </ul>	

	<ul style="list-style-type: none"> <li>● Press the rotary encoder (7) to confirm the selection and return to the upper menu interface.</li> </ul>
<p style="text-align: center;"><b>Image Hue</b></p> 	<p><b>Setting the image hue</b></p> <ul style="list-style-type: none"> <li>● In the <b>Settings</b> submenu, rotate the rotary encoder (7) to select the <b>Image Hue</b> option</li> <li>● Press the rotary encoder (7) to enter the submenu of the image hue.</li> <li>● Rotate the rotary encoder (7) to switch between Warm and Cold.</li> <li>● Press the rotary encoder (7) to confirm your selection and exit to the upper menu interface.</li> </ul> 
<p style="text-align: center;"><b>Factory Reset</b></p> 	<p><b>Reset to factory settings</b></p> <ul style="list-style-type: none"> <li>● In the <b>Settings</b> submenu, rotate the rotary encoder (7) to select the <b>Factory Reset</b> option.</li> <li>● Press the rotary encoder (7) to enter the submenu.</li> <li>● Rotate the rotary encoder (7) to select "Yes" for restoring factory settings or "No" for canceling the operation.</li> <li>● Press the rotary encoder (7) to confirm the selection.</li> <li>● If "Yes" is selected, the scope will reboot automatically.</li> <li>● If "No" is selected, the operation is canceled and return to the upper menu.</li> </ul> <p>After the Factory Reset is selected, the following functions will be restored to default settings:</p> 

		<ul style="list-style-type: none"> <li>- <b>Image Mode:</b> White hot</li> <li>- <b>Standby:</b> Off</li> <li>- <b>Zeroing Distance:</b> A100</li> <li>- <b>Video Output:</b> Off</li> <li>- <b>Ultraclear Mode:</b> Off</li> <li>- <b>Wi-Fi:</b> Off</li> <li>- <b>Optical Magnification:</b> 3.5×(TH35:2.5×)</li> <li>- <b>Gravity Sensor:</b> Off</li> <li>- <b>Calibration Mode:</b> A</li> <li>- <b>Unit of Measure:</b> Meter</li> <li>- <b>Compass:</b> Off</li> <li>- <b>Status Auto Hiding:</b> Off</li> </ul>
	<p><b>Info</b></p> 	<p><b>Show the device information</b></p> <ul style="list-style-type: none"> <li>● In the <b>Settings</b> submenu, rotate the rotary encoder <b>(7)</b> to select the <b>Factory Reset</b> option.</li> <li>● The relevant information of riflescope will be shown by a short press of the rotary encoder <b>(7)</b>.</li> <li>● This item allows the user to view the following information about the riflescope: the product model, GUI version, SYS Info, Boot version, FPGA, PN and SN number of the riflescope, Hardware version and FCC ID.</li> <li>● Press and hold the rotary encoder <b>(7)</b> to return to the upper menu interface.</li> </ul> 



## 18 PIP Function

Picture-in-Picture (PIP) provides a floating window independent of the main image. This window shows the image which is enlarged to 2× in a certain area centered on the reticle of the main image.

- On the home screen, press and hold the **Palette button (6)** to switch the PIP function on/off.
- When the PIP is on, a separate 'window' is appeared on the top of the display simultaneously with the main image.
- When the main image is enlarged by rotating the **encoder (7)**, the image shown in the PIP window is also enlarged accordingly.

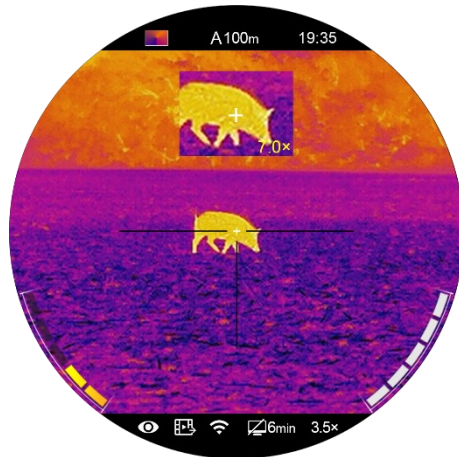

## 19 Stadiametric Rangefinder

The Tube series provides stadiametric rangefinder, which allows you to calculate the approximate distance from a target with a known size.

- On the home screen, press and hold the brightness button **(4)** to turn

the stadiametric rangefinder function on.

- When the function is on, two lines used for measuring appear in the middle part of the image, and three icons of pre-configured objects and the values of measurement distance are displayed on the right side.
- Three pre-defined target values are provided as follows:
  - Deer: 1.7m high
  - Wild boar: 0.9m high
  - Hare: 0.2m high
- Adjust the device to locate the target in the center of the display area. Rotate the rotary encoder **(7)** clockwise to enlarge or anticlockwise to reduce the width of the measurement lines, so that the target is completely between the measurement lines. While adjusting the width of the measurement lines, the rangefinder values on the right change accordingly.
- The color and center position of the measurement line are synchronized with the reticle.
- If you want to change the measurement unit, please go to **Main**

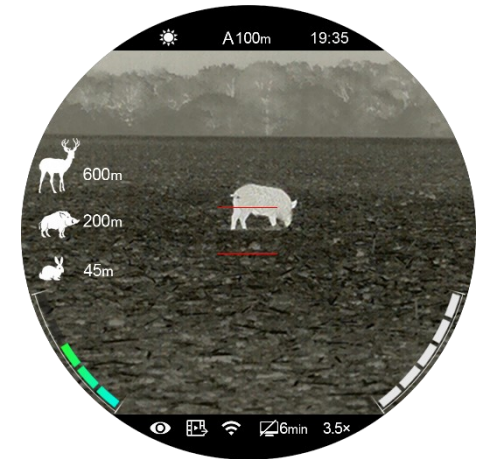

**Menu-Settings-Units of Measure** for modification.

- Press and hold the brightness button **(4)** to exit this function.

## 20 Status Auto Hiding

This function is used to automatically hide the GUI information on the interface other than the reticle, so to make the image unobtrusive.

- Rotate the rotary encoder **(7)** to select **Settings** option in the main menu.
- Press the rotary encoder **(7)** to enter the Settings submenu, and rotate the rotary encoder **(7)** to select **Status Auto Hiding** option.
- Press the rotary encoder **(7)** to enter the submenu of Status Auto Hiding option and then select On or Off by rotating the rotary encoder **(7)**.
- After the status auto hiding is enabled, all GUI icons including the status bar will be automatically hidden and only the image and reticle are displayed if there is no operation within 8s.
- The GUI information will be displayed again with the press of any button.
- Only after the GUI is displayed, the button and menu can be manipulated.

## 21 Wi-Fi

The Tube series has a built-in Wi-Fi module. The device can connect wirelessly to a mobile apparatus (laptop or smartphone) via Wi-Fi.

- To enable the wireless module, enter the main menu by long pressing the rotary encoder **(7)**.
- Rotate the rotary encoder **(7)** to select the **Wi-Fi** option.
- Press the rotary encoder **(7)** briefly to turn on/off Wi-Fi module.
- After the Wi-Fi of the scope is enabled, search for the Wi-Fi signal with the name "Tube\_XXXXXX" on the mobile device, of which, XXXXXX is a 6-bit serial number composed of digits and letters.
- Select the Wi-Fi, enter the password and connect. The initial password is 12345678.
- When Wi-Fi is successfully connected, you can control the scope via the mobile app.

### Setting Wi-Fi name and password

The Wi-Fi name and password of Tube series can be reset in the **InfiRay Outdoor** application.

- After connected with the mobile device, find and click the "**Setting**" icon  in the **InfiRay Outdoor** to enter the setting interface.

- In the text box, enter and submit the new name (SSID) and password of the Wi-Fi.
- It needs to reboot the device to take the new name and password effect.

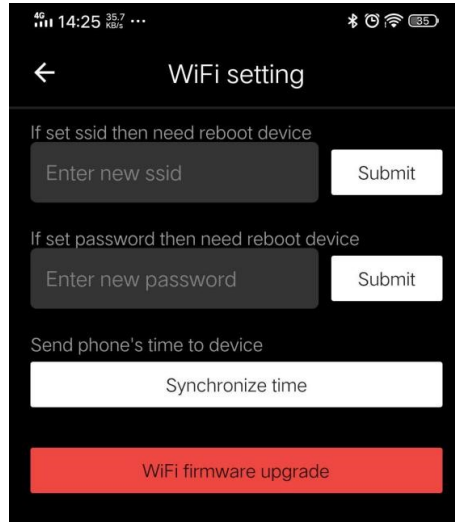

### Note

- After the device is restored to the factory settings, the name and password of the Wi-Fi will also be restored to the default factory default settings.

## 22 Update and InfiRay Outdoor

The Tube series thermal imaging riflescopes supports **InfiRay Outdoor** technology, which allows you to transmit the image from the thermal imager to the smartphone or tablet via Wi-Fi in real time mode.

You can find detailed instructions on **InfiRay Outdoor** in the separate

brochure at the site [www.infirayoutdoor.com](http://www.infirayoutdoor.com).

The design of the riflescope provides the software update option.

Updating is possible via the **InfiRay Outdoor** application. Also, it is feasible to download and update software from the official website ([www.infirayoutdoor.com](http://www.infirayoutdoor.com)).

### About InfiRay Outdoor

- You can get **InfiRay Outdoor** application in the official website, or search **InfiRay Outdoor** in App store to download App, or scan the following QR code to download.



- When installation completed, open **InfiRay Outdoor** application.
- If your device has been connected to a mobile device, enable mobile data on it. After the device accesses the Internet, an update prompt will be displayed automatically. Click **Now** to download the latest version immediately or click **Later** to update later.
- **InfiRay Outdoor** will automatically store the last connected device. So, if the riflescope has not connected with your mobile device, but linked to **InfiRay Outdoor** before, the update prompt will appear if there is an



update when turning on **InfiRay Outdoor**. You can download the update first via mobile Wi-Fi and then connect the riflescope with mobile device to finish the update.

- After finishing the update, the device will root.

## 23 Technical Inspection

It is recommended to carry out a technical inspection each time before using the riflescope. Check the following:

- The riflescope appearance (there should be no cracks on the body).
- The condition of the object lens and eyepiece (there should be no cracks, greasy spots, dirt or other deposits).
- The state of rechargeable battery (it should be charged).
- The controls/buttons should be in working order.

## 24 Maintenance

The maintenance should be carried out at least twice a year and includes

the following steps:

- Wipe the external surface of metal and plastic parts off dust with a cotton cloth. Silicone grease may be used for cleaning process.
- Clean the electric contacts and battery slots on the riflescope using a non-greasy organic solvent.
- Check the optics of the lens and the eyepiece. If necessary, remove the dirt and sand from the optics (it is perfect to use a non-contact method). Cleaning of the exterior of the optics should be done with cleaners designed especially for this purpose.

## 25 Troubleshooting

The table below lists all the problems that may occur when operating the riflescope. Carry out the recommended checks and troubleshooting steps in the order shown in the table. If there are defects that are not listed in the table or it is impossible to repair the defect yourself, return the riflescope for repair service.

**Possible problems and solutions**

Faults	Possible Causes	Solutions
The scope cannot be started	The battery is out of charge	Charge the battery
The device cannot be powered by an external power supply	The USB cable is damaged	Replace the USB cable
	The external power supply is insufficient	If necessary, check the external power supply
Images are fuzzy, not clear, not balanced, with strings	Calibration is required	Calibrate the images as instructed in the manual
The Image is too dark.	The display brightness level is too low.	Adjust the display brightness
The GUI icons are clear but images are blurry	The lens is not focused	Rotate the lens focus ring to adjust the focus
	There is dust or condensate on the interior or exterior optical surfaces of the lens.	Wipe off the outer optical surface by using a soft cotton cloth. Let the riflescope dry by leaving it in a warm environment for 4 hours.
The position of the reticle moves after shooting	The riflescope is not mounted securely or the mount is not fixed on the riflescope.	<p>Check that the riflescope has been securely mounted.</p> <p>Make sure you are using the same type and caliber of the bullets as when the riflescope and weapon were initially zeroed.</p> <p>If your riflescope was zeroed in the summer and using in the winter (or the other way round), a slight shift of the zero point is possible.</p>
The scope cannot focus	Configuration error	<p>Set the scope according to the <b>Power on and Image Setting</b> section.</p> <p>Check the outer surface of the objective lens and eyepiece, and if necessary, wipe off any dust and frost on it.</p>

		In cold weather, a special antifogging coating can be applied (such as those used on eyeglasses or car rearview mirrors).
The device cannot connect with the smartphone or tablet PC.	The Wi-Fi password is incorrect	Input the correct password
	There are too many Wi-Fi signals around the device.	Move the device to an area with no or fewer Wi-Fi signals.
Wi-Fi signals are lost or interrupted	Smartphone or tablet is out of range of a strong Wi-Fi signal. Or there are obstacles between device and the smartphone or tablet (such as concrete wall).	Move the device to a place where you can receive Wi-Fi signals.
The observed target disappears	Observe the target through the glass	Remove the glass from the field of vision.
The image quality is poor or the detection range is reduced.	These problems may occur due to the weather condition, such as snow, rain, fog etc.	
When the device is used at a low temperature, the imaging quality is poorer than that at normal temperature.	<p>At temperatures above 0°C, the temperature rise varies with the observed objects (environment and background) due to different heat conductivity coefficients. As a result, high-temperature contrast occurs and the image quality is better.</p> <p>At low temperatures, the observed targets (background) usually cool down to a similar temperature because of reduced temperature contrast. Therefore, the image quality (details in particular) is poor, which is a characteristic of thermal imaging devices.</p>	

## 26 Legal and Regulatory Information

Wireless transmitter module frequency range:

**WLAN: 2.412-2.472GHz (For EU)**

Wireless transmitter module power<20dBm (only for EU)

 IRay Technology Co., Ltd. thus declares that the Tube series thermal imaging rifle scope complies with the directives 2014/53/EU and 2011/65/EU. The full text of the EU declaration of conformity as well as additional information are available at: [www.infirayoutdoor.com](http://www.infirayoutdoor.com). This device may be operated in all member states of the EU.

### FCC Statement

**FCC-ID: 2AYGT-TH35**

#### Labeling requirements

This device complies with part 15 of the FCC Rules. Operation is subject to the following two conditions: (1) This device may not cause harmful interference, and (2) this device must accept any interference received,

including interference that may cause undesired operation.

#### Information to the user

Any Changes or modifications not expressly approved by the party responsible for compliance could void the user's authority to operate the equipment.

**Note:** The manufacturer is not responsible for any radio or TV interference caused by unauthorized modifications to this equipment. Such modifications could void the user's authority to operate the equipment.

**Note:** This equipment has been tested and found to comply with the limits for a Class B digital device, pursuant to part 15 of the FCC Rules. These limits are designed to provide reasonable protection against harmful interference in a residential installation. This equipment generates uses and can radiate radio frequency energy and, if not installed and used in accordance with the instructions, may cause harmful interference to radio communications. However, there is no guarantee that interference will not occur in a particular installation. If this equipment does cause harmful interference to radio or television reception, which can be determined by turning the equipment off and on, the user is encouraged to try to correct the interference by one or more of the following measures:

- Reorient or relocate the receiving antenna.

- Increase the separation between the equipment and receiver.
- Connect the equipment into an outlet on a circuit different from that to which the receiver is connected.
- Consult the dealer or an experienced radio/TV technician for help.

This equipment complies with FCC RF radiation exposure limits set forth for an uncontrolled environment.

### **Body-worn Operation**

This device was tested for typical body-support operations. To comply with RF exposure requirements, a minimum separation distance of 0.5cm must be maintained between the user's body and the handset, including the antenna. Third-party belt-clips, holsters, and similar accessories used by this device should not contain any metallic components. Body accessories that do not meet these requirements may not comply with RF exposure requirements and should be avoided. Use only the supplied or an approved antenna.

We, IRay Technology Co., Ltd., hereby declare that this product was tested conforming to the applicable FCC rules under the most accurate measurement standards possible, and that all the necessary steps have been taken and are in force to assure that production units of the same

equipment will continue to comply with the Commissions requirements.