



**IRay Technology Co., Ltd.**

Tel: 0086-400-999-3800

Email: [infiRayOutdoor@infiRay.com](mailto:infiRayOutdoor@infiRay.com)

Web: [www.infiRayOutdoor.com](http://www.infiRayOutdoor.com)

Add.: 11th Guiyang Street, YEDA, Yantai, P.R. China



**User Manual**

**V1.0**

**TUBE<sup>SE</sup> | Thermal Imaging Scope**

**TL35 SE/TL25 SE**

## Important Safety Information

### Environmental influences

- Never point the lens of the device directly at intense heat sources such as the sun or laser equipment. The objective lens and eyepiece can function as a burning glass and damage the interior components.
- Avoid touching the metal surface (cooling fins) after exposure to sunlight or cold.

### Risk of swallowing

**Caution:** Do not place this device in the hands of small children. Incorrect handling can cause small parts to come loose which may be swallowed.

### Safety instructions for use

- Handle the device with care: rough handling can damage the internal battery.
- Do not expose the device to fire or high temperatures.
- Always store the device in its carrying bag in a dry, well-ventilated space.

- Do not expose your device to extreme temperatures lower than - 20°C and higher than + 50°C.
- If the device has been damaged, send the device to our after-sales service for repair.

### User information on the disposal of electrical and electronic devices (private households)

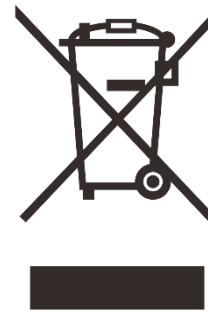

2012/19/EU (WEEE directive): Products marked with this symbol cannot be disposed of as unsorted municipal waste in the European Union. For proper recycling, return this product to your local supplier upon the purchase of equivalent new equipment, or dispose of it at designated collection points. For more

information see: [www.recyclethis.info](http://www.recyclethis.info).

### For business customers within the European Union

Please contact your dealer or supplier regarding the disposal of electrical and electronic devices. He will provide you with further information.

## Information on disposal in other countries outside of the European Union

This symbol is only applicable in the European Union. Please contact your local authority or dealer if you wish to dispose of this product and ask for a disposal option.

## Intended use

The device is intended for displaying heat signatures during nature observation, remote hunting observations and for civil use. This device is not a toy for children.

Use the device only as described in this operating manual. The manufacturer and the dealer accept no liability for damages which arise due to non-intended or incorrect use.

## Function test

- Before use, please ensure that your device has no visible damage.
- Test to see if the device displays a clear, undisturbed image.
- Check that the settings for the thermal imaging monocular are correct. See the notes in the section **Power On and Image Settings**.

## Installing/Removing the battery

The TUBE SE Series Thermal Imaging Scope is equipped with a built-in a battery pack that cannot be removed.

# 1 Specifications

Model	TL25 SE	TL35 SE
<b>Detector Parameters</b>		
Type	Uncooled Vox	
Resolution	384 × 288	
Pixel Size, μm	12	
NETD, mk	≤ 25	
Frame Rate, Hz	50	
<b>Optical Characteristics</b>		
Objective Lens, mm	25	35
Field of View, °	10.5 × 7.4	7.5 × 5.3
Linear Field of View (H×V), m@100m	18.4 × 13.0	13.2 × 9.3
Optical Magnification, ×	2.0	3.0
Digital Zoom, ×	1 ~ 4	1 ~ 3
Eye Relief, mm	50	
Exit Pupil Diameter, mm	6	
Diopter Adjustment, D	-5 ~ +4	
Detection Range, m (Target Size: 1.7m×0.5m, P(n)=99%)	1300	1800
<b>Display Parameters</b>		

Type	OLED
Resolution	1536×1080 (0.43")
<b>Power Supply</b>	
Battery	Built-in 18650 battery/3350mAh
Max. Operating Time (t=22°C), h*	11
External Power Supply	5V (Type C)
<b>Physical Characteristics</b>	
Wi-Fi / APP	Support (InfiRay Outdoor)
Photo / Video Recording	Support
Recoil activated video	Support
MIC / Bluetooth	Support
Memory Capacity, GB	32
IP Rating	IP67
Operating Temperature, °C	-20 ~ +50
Weight, g	< 720
Dimension, mm	310 × 70 × 70
<b>Connections and Compatibilities</b>	
Max. Recoil Power on Rifled Weapon (Eo), Joules	6000
Compatible Mounts	25.4mm ring

\* The actual service time depends on the use frequency of functions like Wi-Fi, video recording, etc.

- Improvements may be made to the design and software of this product to enhance its features without prior notice.
- You can download this User Manual at our official website: [www.infirayoutdoor.com](http://www.infirayoutdoor.com).

## 2 Package

- TUBE SE Series Thermal Imaging Scope
- Eyeshade
- Picatinny rail clamp
- Portable bag
- Type-C cable
- Power adapter (for multiple countries)
- Lens cloth
- Heated target for zeroing

## 3 Introduction

TUBE SE Series is an infrared scope for outdoor hunting. Designed based on infrared thermal imaging principles, it requires no external light sources during the day and at night, in all hard weather conditions (such as rain, snow, fog, and haze). It can be used without being affected by strong light and to observe even targets behind obstacles (such as branches, grass, and shrubs).

TUBE SE Series has a built-in power supply solution for a long operation duration, and can be widely used for hunting, observation, and positioning in low visibility conditions.

TUBE SE Series adopts a 25.4mm standard pipe diameter that features a smaller size and lighter weight, meeting the requirements of the general clamp interface.

## 4 Features

- 12 $\mu$ m self-developed detector
- High image quality

- Low power consumption, long battery life
- Standard 25.4mm pipe diameter
- Long detection range
- 50Hz frame rate
- Built-in 32GB memory space, supporting photographing and video recording
- Built-in Wi-Fi module, supporting App connection
- Built-in compass and motion sensor
- Expandable laser rangefinder function, with a measuring range up to 999m
- PIP (picture-in-picture) function
- Pixel defect correction
- Convenient operation interface

4. Controller
5. Power button
6. Lens focus ring
7. Lens cap
8. Objective lens
9. USB rubber cover
10. Type C port
11. LED indicator

## 5 Components and Controls

1. Eyeshade
2. Eyepiece diopter adjustment ring
3. Zoom handwheel

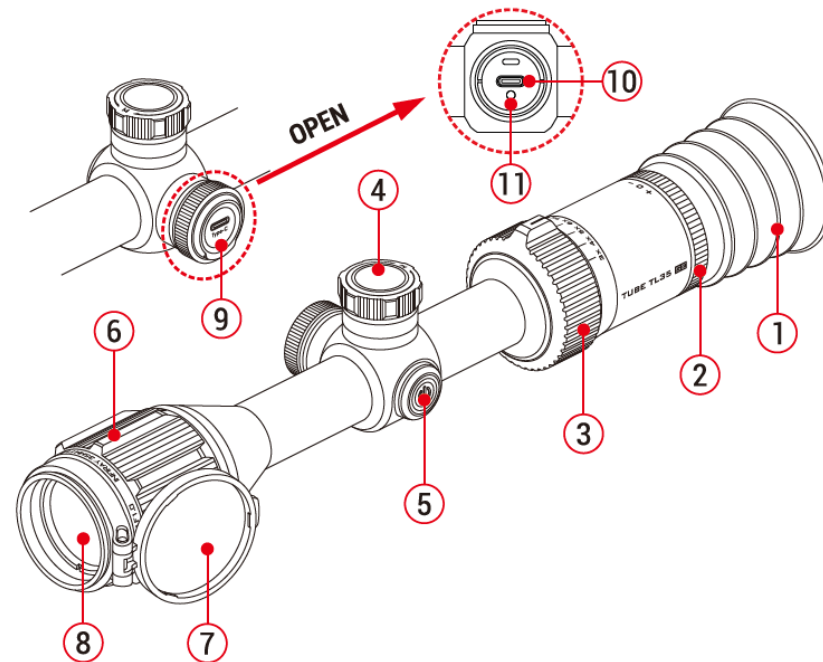

# 6 Button Operation



Button	Current Status	Short Press	Long Press	Rotate
<b>Power button</b>	Powered off	—	Power on the device	—
	Home screen	Image calibration	Power off / Standby the device	—
	Standby mode	Wake up the device	—	—
	Single ranging mode when the laser rangefinder is connected	Perform single ranging	—	—
	Main menu interface	Return to the upper menu without saving	—	—
	Defective pixel calibration interface	Add / Delete defective pixels	—	—
<b>Zoom handwheel</b>	—	—	—	Adjust the image magnification (clockwise - zoom in; counterclockwise - zoom out)
<b>Power button + Controller</b>	Home screen	Switch ranging mode between continuous ranging and single ranging when the laser rangefinder is connected	<b>For 2s:</b> turn on / off the laser rangefinder function <b>For 8s:</b> active / hide the reticle and its functions	—
	Zeroing interface	—	Freeze the image	—
<b>Controller</b>	Home screen	<b>One time:</b> enter the shortcut	<b>For more than 2s:</b> enter the	<b>Clockwise</b> - switch the image mode

		menu interface <b>Twice:</b> take a photo	main menu interface	<b>Counterclockwise</b> - adjust the image brightness
	Shortcut menu interface	Adjust parameters of the function	Save and back to the upper interface	Switch menu options
	Main menu interface	Confirm selection / Enter the submenu		
	Pixel defect calibration / Zeroing / Laser calibration interface	Switch the moving direction		<b>Clockwise</b> - move the reticle rightward / downward <b>Counterclockwise</b> - move the reticle leftward / upward



## 7 Charging the Built-in Battery

TUBE SE Series is built in a rechargeable 18650 battery pack, with battery power for up to 11 hours of normal operating time. The battery should be fully charged before the first use.

- Open the USB rubber cover (9) to reveal the Type C port (10).
- Plug the Type C end of the supplied USB cable (12) into the Type C port (10) of the TUBE SE Series.
- Connect the other end of the USB cable to the power adapter (13), and insert the power adapter (13) into a 100-240V power socket (14) for charging.
- When charging, a lightning charging icon appears on the battery icon , and the **LED indicator (11)** on the device is red. When the **LED indicator (11)** turns green, it indicates that the charging is completed.
- During use, if the battery icon turns red , it indicates that the battery level is low. Please charge the battery in time to avoid reducing the service life of the device due to the over discharge of the battery.

### Safety Precautions

- When charging, please use the 5V2A power adapter compatible with the device. Using any other type of power adapter may cause irreversible damage to the battery or the adapter itself.
- If the device is not used for a long time, the battery should be partially charged, not fully charged or discharged.
- Do not charge the device immediately after it is moved to a warm environment from a cold environment. Wait for 30 to 40 minutes for preheating.
- Do not use the charger if it is modified or damaged.
- The device should be charged at a temperature of 0°C to +40°C. Otherwise, the battery life will be significantly reduced.
- When charging, please do not leave the battery unattended.

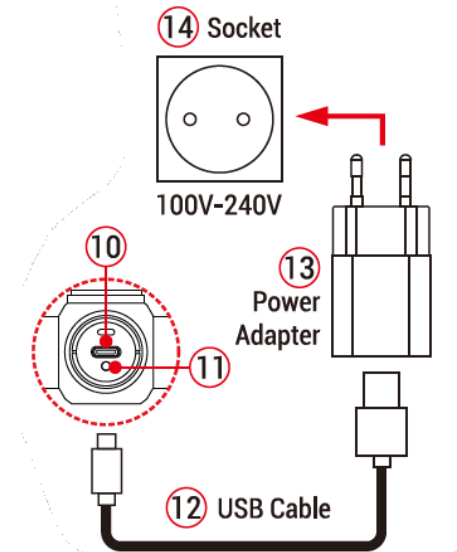

- Do not connect the battery to the power supply for more than 24 hours after it is already fully charged.
- It is not recommended to connect third-party devices that consume more energy than the allowed value.
- The device is equipped with a short circuit protection system, but conditions that may lead to a short circuit should be avoided.
- Use the device at the recommended operating temperature from -20°C to +50°C. Do not use the device beyond this temperature range or it may shorten the battery life.
- When the device is used under sub-zero temperature, the battery capacity drops. This is normal and does not indicate a defect.

## 8 Mounting and Usage

### Mounting on the weapon

To ensure aiming accuracy, please fix TUBE SE Series at a proper position on the weapon.

- TUBE SE Series needs to be fixed with an adapter clamp, such as

a simple Picatinny rail clamp provided in the package. TUBE SE Series is designed with a 25.4mm diameter pipe and can be used with a standard clamp for 25.4mm diameter pipes. Proper tools can be used to mount TUBE SE Series according to the supplier's installation suggestions and steps.

- The mounting position should be adjusted according to the distance between the eye and eyepiece (eye relief) as specified in the specifications and the sense of use and comfort. If you fail to follow this suggestion, the eyepiece may hurt the shooter during the shooting.
- It is recommended to mount the scope as low as possible, but keep it away from the barrel or other devices.
- It is recommended to use a torque wrench to tighten the screws of the mounting clamp, so as to avoid damaging the scope body due to being over-tightened, and the recommended torque shall not exceed 2.5Nm.
- When the scope is used for hunting, please carry out the zeroing operation first according to the instructions as specified in Section **Zeroing** in this manual.

- When using the scope at night or in a dark environment, it is recommended to use an eyeshade to avoid being found.

## Power-on and Settings

- Remove the lens cap (7).
- Press and hold the **Power button (5)** for 2s to start the device, and wait for several seconds to enter the home screen to complete the startup.
- Adjust the clarity of icons on the display by rotating the eyepiece diopter adjustment ring (2).
- Rotate the lens focus ring (6) to adjust the focal length;
- **Set the image mode:** On the home screen, turn the **Controller (4)** clockwise to set the palette mode, of which the options include white hot - black hot - pseudo-color - red hot - target highlighting in order.
- **Set the screen brightness:** On the home screen, turn the **Controller (4)** counterclockwise to adjust the display brightness from level 1 to 5. A short prompt of the corresponding brightness icon will appear at the bottom of the display.
- **Set the image sharpness:** On the home screen, short press the **Controller (4)** to enter the shortcut menu to set the image sharpness.
- **Image calibration:** On the home screen, short press the **Power button (5)** to perform the image calibration, when performing background correction, please close the lens cap (7) first. The calibration mode can be set in the main menu.
- On the home screen, press and hold the **Controller (4)** for more than 3s to enter the main menu interface for more functions.
- After using, press and hold the **Power button (5)** for 3 seconds to enter the power-off interface. Release the button until the countdown icon turns from 3 to 0, then a "Data saving ..." prompt interface is displayed. When the data is saved, the display turns black and the device is off. **When the device**

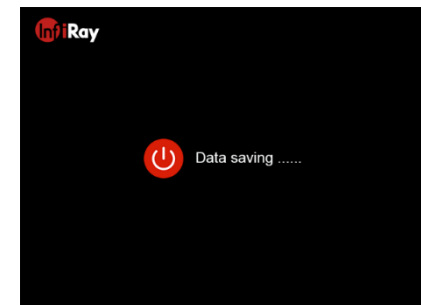
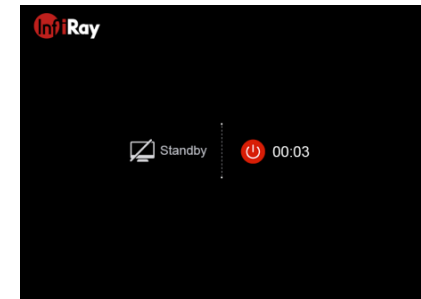

is powering off and saving data, do not disconnect it from its power source. Otherwise, the data cannot be saved.

- When releasing the button during the countdown, the device will enter the standby mode. Press the **Power button (5)** again to wake up the device.

## 9 Status Bar

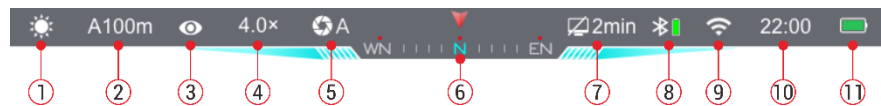

The status bar is located at the top of the image interface, and displays the information related to the current operating status of the device.

1. Current image mode (☀️: white hot; 🌙: black hot; 🔥: red hot; 🎯: target highlight; 🌈: pseudo-color)
2. Current zeroing profile and zeroing distance (e.g., A100m)
3. Ultraclear mode: (👁️/👁️/👁️: the Ultraclear mode is off; 👁️: the Ultraclear mode is on)
4. Current visual magnification (TL35 SE: 3.0× to 9.0× adjustable,

TL25 SE: 2.0× to 8.0× adjustable, with an interval of 1.0)

5. Calibration mode (A: Auto Calibration; M: Manual Calibration; B: Background Calibration). In mode A, the device automatically performs shutter correction at a certain interval.
6. Compass (displayed when the compass is on)
7. Standby status and time (off by default)
8. Bluetooth status (❌: Bluetooth is off. ⚡️: Bluetooth is on but not successfully connected to the laser rangefinder module. ⚡️🔋: Bluetooth is on and successfully connected to the laser rangefinder module, the battery icon 🔋 shows the power status of the rangefinder module)
9. Wi-Fi status (🚫: Wi-Fi OFF; 📶: Wi-Fi ON)
10. Clock (Set it in the main menu or in the InfiRay Outdoor App)
11. Power status of the built-in battery pack

Icon	Battery Status
	The power is more than 20% and sufficient.
	The power is between 10% and 20%.
	The power is less than 10%.
	The battery is in charging.

## 10 Zeroing

TUBE SE Series uses the “freezing” zeroing method. It is better to perform zeroing in environments within the operating temperature range of the scope.

- Fix the scope on the weapon with a frock clamp (For details, refer to **Section 8 Mounting and Usage**).
- When using the scope for the first time, press and hold the **Controller (4) + Power button (5)** for more than 8s to enable the hidden reticle and zeroing functions.
- Select a target at a certain distance, such as 100m.
- Adjust the scope according to the operating instructions as described in **Section 8 Power-on and Settings**.
- Select the zeroing profile (refer to **Main Menu - Zeroing Profile**).
- Press and hold the **Controller (4)** to enter the main menu interface.
- Rotate the **Controller (4)** to select **Reset Zeroing Distance** item (🎯). Briefly press the **Controller (4)** to enter the submenu.
- According to the selected target distance, select or add the new zeroing distance (refer to **Main Menu - Reset Zeroing Distance**).

- After selecting the zeroing distance, rotate the **Controller (4)** to select the Zeroing function (—|—), and press the **Controller (4)** to enter zeroing interface. The coordinate positions of the reticle (X-axis and Y-axis) are displayed in the upper left corner of the screen.

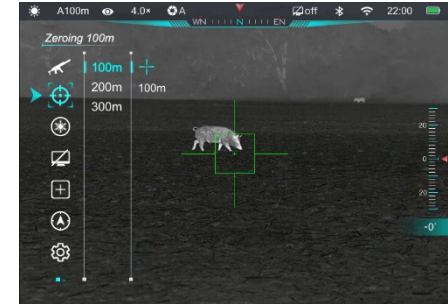

- Aim and shoot at the target.
- Observe the position of the actual point of impact, and assume that the red mark **x** in the figure on the right is the position of the point of impact (**This mark is only for illustration. It should actually be a bullet hole**).



- If the point of impact and the aiming point (the center point of the reticle) do not match, keep the aiming position still, and meanwhile, press and hold the **Controller (4) + Power button (5)** at the same time until a snow-like freezing icon ❄️ appears on the left of the screen, and the image

is frozen.

- Rotate the **Controller (4)** to move the reticle until the reticle matches the point of impact. Rotate clockwise to move the reticle right or down, and rotate anticlockwise to move the reticle left or up.
- Press the **Controller (4)** to switch the movement direction between the X and Y. The position of the cursor ► indicates the current selected option, with the icon turning blue.
- After moving the reticle, a little white dot appears on the screen, indicating the position of the reticle before moving.
- After moving the reticle position to the actual point of impact, press and hold the **Controller (4)** to save the reticle position and return to the home screen.
- Repeat aiming and shooting, until the position of the point of impact is consistent with that of the aiming point.



**Note:** After the zeroing position is set up, you can switch the option through **Zeroing Distance** in the shortcut menu.

## 11 Calibration

When the image is degraded or uneven, it can be improved by calibration. Calibration can balance the background temperature of the detector and eliminate the defects in the image.

- On the home screen, short press the **Power button (5)** to perform the image calibration.
- There are three calibration modes: Automatic calibration (A), Manual calibration (M), and Background calibration (B), that can be set in the main menu (refer to the **Main Menu - Calibration**).
- **Automatic (A):** Device will calibrate automatically according to the software algorithm. There is no need to close the lens cover (the internal shutter covers the sensor). Before automatic calibration, there will be a 5 second countdown prompt behind the shutter icon on the status bar, that can be cancelled this calibration during countdown with a short press of the **Power button (5)**. In this mode, user can also finish the calibration manually with a short press of the **Power button (5)**.
- **Manual (M):** In this mode, it needs to finish the shutter calibration

manually without closing the lens cap (the internal shutter covers the sensor).

- **Background (B):** In this mode, the lens cap need be covered before calibration. After short pressing the **Power button (5)**, a prompt '**Cover lens during calibration**' will be displayed for 2s on the home screen, then finish the background calibration after 2s.
- When the device is just started, no matter which calibration mode is selected, the device will automatically and continuously perform the shutter calibration.

## 12 Magnification and Digital Zoom

The TUBE SE Series supports to zoom the image for quickly increase the basic magnification. The magnification rang is engraved on the housing of the eyepiece near the **Zoom handwheel (3)**.

- On the home screen, turn the **Zoom handwheel (3)** to align the indication line of the **Zoom handwheel (3)** with the corresponding magnification of the eyepiece to switch the magnification.
- The TL35 SE supports the magnification from 3.0 to 9.0, by which

the image can be magnified by 1 time to 3 times. The TL25 SE supports the magnification from 2.0 to 8.0, by which the image can be magnified by 1 time to 4 times.

- The magnification is displayed on the status bar of the display in real time.

## 13 Photographing / Video Recording

TUBE SE Series is equipped with a 32GB built-in memory space, which can be used for photographing and video recording. The photo and video files will be named by time, so it is recommended to reset the system date and time in the main menu before using (refers to **Main Menu - Settings - Date/Time**), or synchronize the system date and time in the InfiRay Outdoor application.

### Photographing

- On the home screen, short press the **Controller (4)** twice to take a photo. The image freezes for 0.5s, and the camera icon appears in the upper left corner of the screen.

- Photos are stored in the internal memory space.
- When the exclamation mark icon  appears on the right side of the camera icon, it prompts that the memory space is insufficient. Check and transfer your videos and images to other media to free up the space.

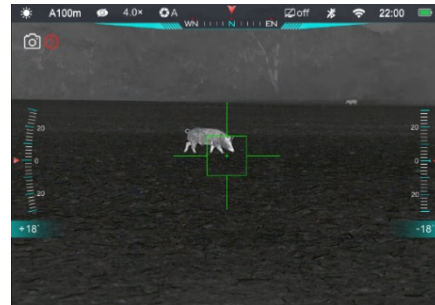

## Video Recording

- On the home screen, briefly press the **Controller (4)** to open the shortcut menu function.
- Rotate the **Controller (4)** to select recording option and press the **Controller (4)** to turn on and start a video recording.



- The recording icon and prompt box showing the recording time appear in the upper right corner of the display, with the time format as 00:00:00 (hour: minute: second).
- During video recording, it can still take photos and operate the menu.
- On the shortcut menu, select the video recording option and press the **Controller (4)** again to turn off and save the video recording.
- All videos and photos will be saved in the built-in storage.

### Note

- The maximum duration of a video recording file is 30 minutes. When the duration is more than 30 minutes, the video will be automatically recorded onto a new file.
- The images taken and the videos recorded are stored in the built-in memory space in the format of IMG\_HHMMSS.jpg (image) and VID\_HHMMSS.mp4 (video), with HHMMSS indicating hour / minute / second.
- The number of files is limited by the internal memory space of the device. Check the remaining space regularly, and transfer your videos and images to other media to free up the space on the





memory card.

## Memory Access

When the device is powered on and connected to a computer, it will be recognized by the computer as a flash memory card. Then, you can access the memory of the device and copy images and videos.

Perform the following operations to copy images and videos:

- Connect the device to a computer through the USB cable.
- Power on the device.
- Double-click My Computer - double-click to open the device named

“Infiray”  - double-click to open the device name “TUBE SE Storage”  to access the memory.

TUBESE\_Storage  
26.9 GB 可用, 共 28.5 GB

- There are different folders named by time in the format of xxxx (year) xx (month) xx (day) in the memory.
- Recorded photos and videos in that day are saved in the corresponding folders
- Select desired files or folders to copy or delete.



## 14 Laser Rangefinder (ILR-1200-1, purchased separately)

TUBE SE Series supports external laser rangefinder modules (bought separately).

For detailed description of the Installation and Usage of the laser rangefinder module, please refer to the manual of the laser rangefinder in its package.

Compared with stadiametric rangefinder, the laser rangefinder is more accurate, with no need to find specific target objects.

- Press and hold the **Power button** on the rangefinder module for 3s to turn on the rangefinder module. The red LED indicator on the rangefinder module blinks before the module is connected with TUBE.
- Long press the **Controller (4)** for more than 3s on the Tube SE series to enter the main menu interface.
- Select the **Bluetooth** option, and make sure the Bluetooth is on.
- The laser rangefinder module will automatically connect with Tube SE series.

- When the battery icon appears on the right side of the Bluetooth icon  on the status bar, it means the Tube is successfully connected with the laser rangefinder module. The LED indicator on the laser rangefinder module turns off.
- Press and hold the **Controller (4) + Power button (5)** on the home screen for 3s at the same time to turn on the laser rangefinder function. A blue rangefinder cursor  appears on the screen.
- Press the **Power button** on the rangefinder module twice to turn on / off the laser indicator.
- There are two ranging modes for selection - continuous ranging (CON) and single ranging (SGL).



- The default mode is the continuous ranging mode. Press the **Controller (4) + Power button (5)** at the same time to switch the ranging mode.

- In the continuous ranging mode, the ranging is in real time and automatic without any operation.
- In the single ranging mode, you need to briefly press the **Power button (5)** to perform the ranging operation.
- The current ranging mode and ranging value are displayed in the upper right corner of the screen.
- When the ranging value shows **MAX**, it means that the target distance has exceeded the maximum distance (999m) of the laser rangefinder.
- Switch the measurement unit according to **Main Menu - Settings - Units of Measure**.
- During continuous ranging, other functions such as photographing and video recording are not affected.
- Press and hold the **Controller (4) + Power button (5)** at the same time to turn off the laser rangefinder function.
- If the target position pointed by the laser indicator is not aligned with the center of the rangefinder cursor on the screen, it needs to calibrate the position of laser rangefinder cursor referring to the **Main Menu - Laser Calibration**.

## 15 Shortcut Menu

The shortcut menu can be used for quickly changing the basic settings of some common functions, including video recording, reticle style, reticle color, image sharpness and zeroing distance.

- On the home screen, press the **Controller (4)** to open the shortcut menu.
- Turn the **Controller (4)** to switch between the following options, and the icon background of the selected option is highlighted.



- **Video Recording** (📹): Turn the **Controller (4)** to select the video recording option, and press the **Controller (4)** to turn the video recording function on/off.
- **Reticle Style** (—|≡): Turn the **Controller (4)** to select the reticle style, and press the **Controller (4)** to switch between 6 styles.
- **Reticle Color** (—|≡): Turn the **Controller (4)** to select the option, and **press** the **Controller (4)** to adjust the colors,

including black, white, red, and green.

- **Image Sharpness** (▲▲): Turn the **Controller (4)** to select the option, and press the **Controller (4)** to adjust the image sharpness from levels 1 to 5.
- **Zeroing Distance** (🎯): Turn the **Controller (4)** to select the option, and press the **Controller (4)** to switch between the distance values saved for the current zeroing profile (e.g. For firearm type A, when you select the option, only the distance values saved for type A are available).
- Press and hold the **Controller (4)** or short press the **Power button (5)** to save the changes and return to the home screen.
- In the shortcut menu, if there is no operation within 5s, the device will automatically save the changes and return to the home screen.

## 16 Main Menu

- On the home screen, press and hold the **Controller (4)** for more than 3s to enter the main menu function.
- Rotate the **Controller (4)** to switch the function options - clockwise

rotation to move downward and anticlockwise to move upward.

- Press the **Controller (4)** to adjust the parameters of the current option or enter its submenu.
- The position of the cursor  indicates the selected option, the icon of which turns from white into blue.
- The operations for submenus are the same as above.
- On any menu interface, press and hold the **Controller (4)** to save the changes and return to the home screen. Press the **Power**

**button (5)** to return to the upper menu without saving the changes.

- If there is no operation within 15s on any menu interface, it will automatically return to the home screen without saving.
- During the continuous operation of the scope (i.e., until the riflescope is turned off), when exiting from the main menu, the cursor  remains at the position before exiting. When you restart the scope and enter the main menu for the first time, the cursor stays at the first menu option.

## Main Menu Features and Descriptions





### PIP



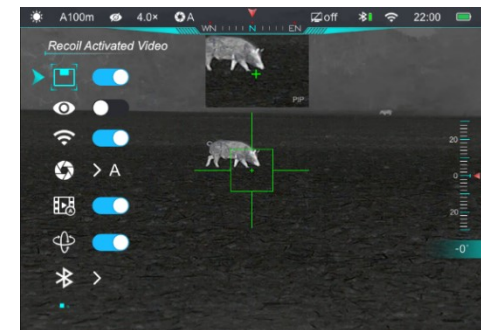





#### Turn on/off PIP



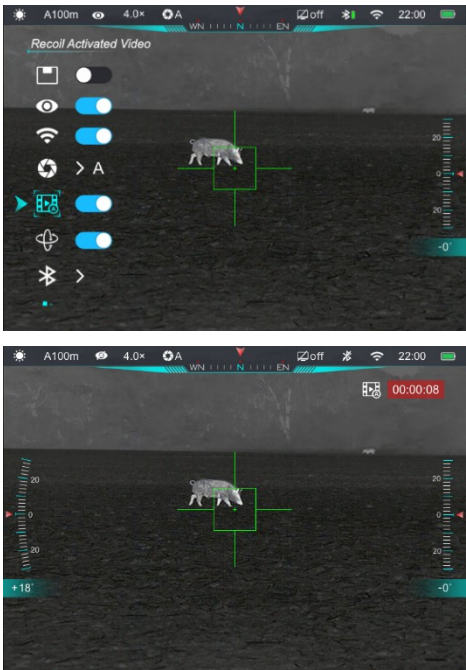

- Press and hold the **Controller (4)** to enter the main menu.
- Rotate the **Controller (4)** to select the **PIP** option (selected by default on the menu after startup).
- Press the **Controller (4)** briefly to turn on /off the PIP function.
- When PIP is on, A separate 'window' is appeared on the top of the display simultaneously with the main image. The window shows part of the image which is magnified by 2× in a certain area centered on the reticle of the main image.
- After magnifying the image on the home screen by turning the **Zoom handwheel (3)**, the image shown in the PIP window will also be magnified by 2×.

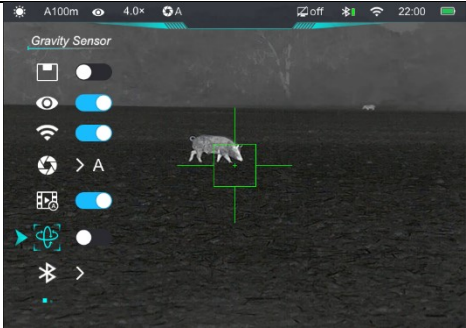

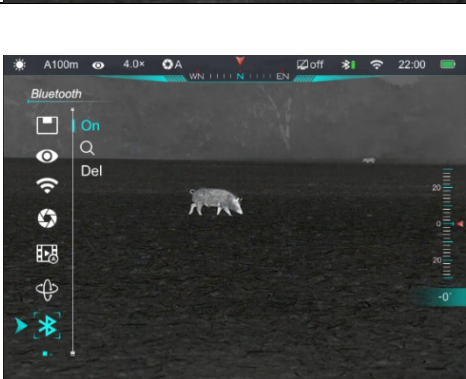
<p><b>Ultra-clear Mode</b></p> 	<p><b>Turn on / off the Ultra-Clear Mode</b></p> <ul style="list-style-type: none"> <li>● Press and hold the <b>Controller (4)</b> to enter the main menu.</li> <li>● Rotate the <b>Controller (4)</b> to select the <b>Ultra-clear mode</b> option.</li> <li>● Press the <b>Controller (4)</b> briefly to turn on / off the Ultra-Clear Mode, during which you hear a click of shutter correction.</li> <li>● When the ultra-clear mode is on / off, the icon in the status bar changes accordingly.</li> </ul>	
<p><b>Wi-Fi</b></p> 	<p><b>Turn on / off the Wi-Fi function</b></p> <ul style="list-style-type: none"> <li>● Press and hold the <b>Controller (4)</b> to enter the main menu.</li> <li>● Rotate the <b>Controller (4)</b> to select the <b>Wi-Fi</b> option.</li> <li>● Press the <b>Controller (4)</b> briefly to turn on / off the Wi-Fi function.</li> <li>● When Wi-Fi is on, the default password (123456) is prompted for 3s behind the icon of Wi-Fi function.</li> <li>● The password is only displayed for the first three times. After the password is changed, it will not be displayed.</li> <li>● When Wi-Fi is on / off, the icon in the status bar changes accordingly.</li> </ul>	
<p><b>Calibration</b></p> 	<p><b>Select calibration mode</b></p> <p>There are three calibration modes: Automatic calibration (A), Manual calibration (M), and Background calibration (B).</p> <ul style="list-style-type: none"> <li>● Press and hold the <b>Controller (4)</b> to enter the main menu.</li> <li>● Rotate the <b>Controller (4)</b> to select <b>Calibration</b> option.</li> <li>● Press the <b>Controller (4)</b> briefly to enter the submenu of Calibration.</li> </ul>	

	<ul style="list-style-type: none"> <li>● Rotate the <b>Controller (4)</b> to select a mode from the following three:             <ul style="list-style-type: none"> <li>- <b>Automatic:</b> Parameters are defined by software algorithms and images are calibrated automatically in this mode.</li> <li>- <b>Manual:</b> Images are manually calibrated by users according to the image effect.</li> <li>- <b>Background:</b> The lens cap or a uniform background must be closed on the lens before calibration.</li> </ul> </li> <li>● Press the <b>Controller (4)</b> briefly to confirm the selection. The icon in the status bar changes accordingly.</li> </ul>	
<p><b>Recoil Activated Video</b></p> 	<p><b>Turn on/off the Recoil Activated Video function</b></p> <ul style="list-style-type: none"> <li>● Press and hold the <b>Controller (4)</b> to enter the main menu.</li> <li>● Rotate the <b>Controller (4)</b> to select <b>Recoil Activated Video</b> option.</li> <li>● Press the <b>Controller (4)</b> briefly to turn on / off the Recoil Activated Video function.</li> <li>● If the <b>Recoil Activated Video</b> function is on, when you shoot, Tube SE will automatically record the video of 3 seconds before shooting and 2 minutes 57 seconds after shooting.</li> <li>● The recording icon and prompt box showing the recording time appear in the upper right corner of the display, with the time format as 00:00:00 (hour: minute: second).</li> <li>● The video will be saved in the built-in storage. If there is a continuous shooting within 3 minutes, only one video will be saved.</li> </ul>	

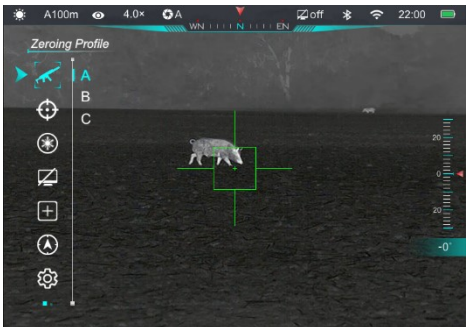
<p style="text-align: center;"><b>Compass and Motion Sensor</b></p> 	<p><b>Turn on/off the Compass and motion sensor function</b></p> <ul style="list-style-type: none"> <li>● Press and hold the <b>Controller (4)</b> to enter the main menu.</li> <li>● Rotate the <b>Controller (4)</b> to select the <b>Compass and Motion Sensor</b> option.</li> <li>● Press the <b>Controller (4)</b> briefly to turn on / off the Compass and motion sensor function.</li> <li>● When it is on, the compass will display in the middle of the status bar on the top, and two scales the motion sensor are displayed on both sides of the screen. When in the main menu interface, only the right-side scale is shown.</li> <li>● The curved scale on the left represents the tilt angle and the vertical ruler on the right represents the pitch angle.</li> </ul>	 
<p style="text-align: center;"><b>Bluetooth</b></p> 	<p><b>Turn on/off the Bluetooth function</b></p> <ul style="list-style-type: none"> <li>● Press and hold the <b>Controller (4)</b> to enter the main menu.</li> <li>● Rotate the <b>Controller (4)</b> to select the <b>Bluetooth</b> option.</li> <li>● Press the <b>Controller (4)</b> briefly to enter the Bluetooth submenu.</li> <li>● Rotate the <b>Controller (4)</b> to select from the following three options: <ul style="list-style-type: none"> <li>- <b>On/Off</b>: select this option and briefly press the <b>Controller (4)</b> to turn on/off Bluetooth function.</li> <li>- <b>Q</b> : this option supports to search for the Bluetooth manually. Select this option and briefly press the <b>Controller (4)</b> to</li> </ul> </li> </ul>	

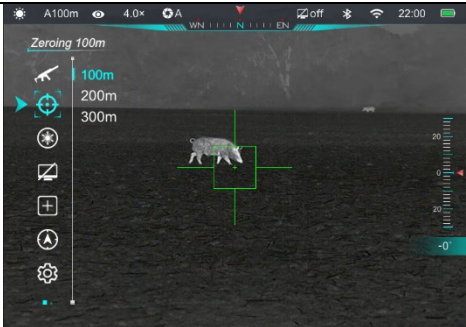
	<p>search for the nearby Bluetooth of the laser rangefinder that will be displayed in the secondary menu, for more than 5. Rotate the <b>Controller (4)</b> to select one and press the <b>Controller (4)</b> briefly to connect.</p> <ul style="list-style-type: none"> <li>- <b>Del:</b> Tube SE will save the connected Bluetooth of the laser rangefinder. Select this option and briefly press the <b>Controller (4)</b> to delete the saved Bluetooth.</li> <li>● The icon in the status bar will change accordingly when the status of Bluetooth changes.</li> </ul>	
<p><b>Zeroing Profile</b></p> 	<p><b>Select a profile for zeroing</b></p> <ul style="list-style-type: none"> <li>● Press and hold the <b>Controller (4)</b> to enter the main menu.</li> <li>● Rotate the <b>Controller (4)</b> to select the <b>Zeroing Profile</b> option.</li> <li>● Press the <b>Controller (4)</b> briefly to enter the secondary menu of Zeroing Profile.</li> <li>● Rotate the <b>Controller (4)</b> to select one from the three zeroing profiles (A, B, C).</li> <li>● Press the <b>Controller (4)</b> to confirm the selection and return to the main menu.</li> <li>● The name of the selected profile on the status bar changes accordingly.</li> </ul>	
<p><b>Zeroing</b></p> 	<p>Please select a zeroing profile and preset a zeroing distance before carrying out any zeroing operation.</p> <p>TUBE SE Series supports any zeroing distance between 1 and 999 meters.</p> <ul style="list-style-type: none"> <li>● Press and hold the <b>Controller (4)</b> to enter the main menu.</li> <li>● Rotate the <b>Controller (4)</b> to select <b>Zeroing</b> option.</li> </ul>	



- Press the **Controller (4)** briefly to enter the submenu of Zeroing, where zeroing distances are displayed.
- There are three types of distance for selection - 100m, 200m and 300m by default.

**Zeroing**



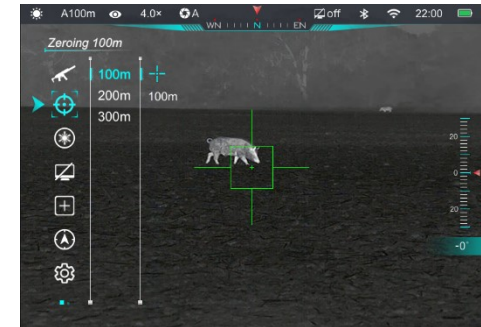

If the preset zeroing distance is consistent with that displayed on the device, you can perform zeroing directly following the steps as below:

- Rotate the **Controller (4)** to select one zeroing distance based on the preset target distance.
- Press the **Controller (4)** briefly to confirm the zeroing distance, and enter the zeroing distance submenu.
- Rotate the **Controller (4)** to select Zeroing function .
- Press the **Controller (4)** briefly to enter the Zeroing interface.
- The **X** and **Y** coordinates of the reticle are displayed on the top left corner of the screen.
- Aim the reticle center of the scope at the bull's eye at the target distance and shoot, and then observe the position of the actual point of impact.
- Keep the aiming position still, and press and hold the **Controller (4) + Power button (5)** at the same time to freeze the image. Meanwhile, the freezing icon is displayed on the screen.
- Rotate the **Controller (4)** to move the reticle position until the reticle center coincides with the



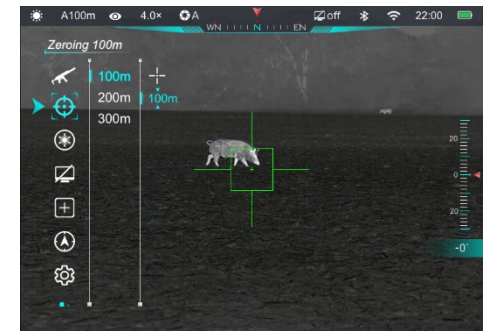

	<p style="text-align: center;"><b>Reset Zeroing Distance</b></p> <p style="text-align: center;">▼ 000 ▲</p>	<p>position of the point of impact. For details, refer to <b>Section 10 Zeroing</b>.</p> <p>If the zeroing distance is not consistent with the preset target distance, this option can be used for setting the zeroing distance.</p> <ul style="list-style-type: none"> <li>● Select an invalid zeroing distance, press the <b>Controller (4)</b> briefly to enter its submenu.</li> <li>● Rotate the <b>Controller (4)</b> to select <b>Reset Zeroing Distance</b> in the submenu.</li> <li>● Press the <b>Controller (4)</b> briefly to activate the zeroing distance resetting function, and then two small triangle symbols are displayed above and below the number 0 .</li> <li>● Rotate the <b>Controller (4)</b> to set the value of the current position, which can be switched between 0 and 9.</li> <li>● Press the <b>Controller (4)</b> briefly to switch between the positions of hundred, ten and one digits.</li> <li>● After setting, press and hold the <b>Controller (4)</b> to save the settings and exit. Meanwhile the zeroing distance changes accordingly.</li> <li>● In addition, the status bar is updated to the new zeroing distance synchronously.</li> <li>● After the zeroing distance is saved, select and enter the zeroing function <math>\text{---} \frac{1}{\text{---}}</math> for zeroing.</li> </ul>
<p><b>Laser Calibration</b></p> 	<p>The laser rangefinder module (purchased separately) needs to be calibrated before first installation and using, which help to make the target position pointed by the laser indicator to align with the center of the rangefinder cursor on the screen.</p> <ul style="list-style-type: none"> <li>● Install the laser rangefinder module on Tube SE Series.</li> </ul>	



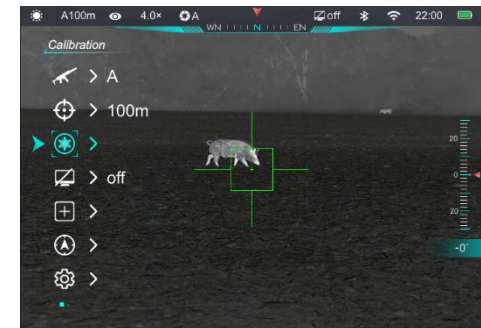



- Press and hold the **Power button** on the rangefinder module for 3s to power on the rangefinder module.
- Turn on the Bluetooth of the TUBE SE Series in the main menu and wait for to connect the rangefinder module successfully until the battery icon appears on the right side of the Bluetooth icon  on the status bar.
- Press its **Power button** twice to turn on / off the laser indicator on the rangefinder module.
- On the home screen, press and hold the **Controller (4) + Power button (5)** for 3s to turn on the laser rangefinder function.
- Press and hold the **Controller (4)** to enter the main menu.
- Rotate the **Controller (4)** to select the **Laser Calibration** option.
- Press the **Controller (4)** briefly to enter the Laser Calibration interface. The blue laser cursor  appears on the screen instead of the reticle, and the prompt information as below shown in the upper left corner.
- Assume that the red "x" in the figure represents the target position aimed at by the laser indicator (it is actually displayed as a red dot).
- Press the **Controller (4)** to switch the option among X, Y or Centre.
  - **X** (horizontal): When X is selected, rotate the **Controller (4)** to move the laser cursor horizontally - clockwise to the right and counterclockwise to the left.
  - **Y** (vertical): When Y is selected, rotate the **Controller (4)** to move the laser cursor vertically - clockwise to the down and counterclockwise to the up.
  - **Centre**: When Centre is selected, press the **Power button (5)** briefly to centre the laser cursor on the screen.
- When the laser cursor is aligned with the position aimed by the laser indicator, press and hold the **Controller (4)** to save







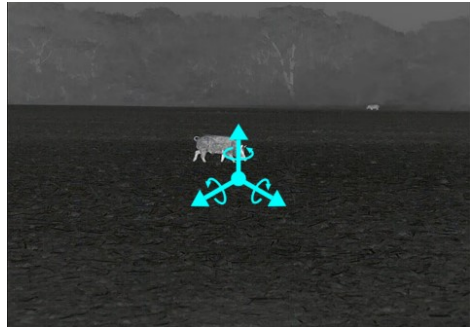

	<p>and exit the laser calibration interface.</p>
<p><b>Standby</b></p> 	<p><b>Set Standby Status and Time</b></p> <ul style="list-style-type: none"> <li>● Press and hold the <b>Controller (4)</b> to enter the main menu.</li> <li>● Rotate the <b>Controller (4)</b> to select the <b>Standby</b> option.</li> <li>● Press the <b>Controller (4)</b> briefly to enter the submenu of Standby, including four options: 2min, 4min, 6min, and off.</li> <li>● Rotate the <b>Controller (4)</b> to select as needed.</li> <li>● Press the <b>Controller (4)</b> briefly to confirm the selection, and then the selected option is displayed on the top status bar.</li> <li>● If Off is selected, the standby function is disabled.</li> </ul> <p><b>Note:</b></p> <ul style="list-style-type: none"> <li>- The standby mode is activated automatically when the device is tilted up or down at an angle of more than 70° and left or right at an angle of more than 30°.</li> <li>- When the device is in the shooting status (horizontally positioned), the standby mode is disabled.</li> </ul> 
<p><b>Pixel Defect Correction</b></p> 	<p>When using the scope, defective (dead) pixels may appear on the sensor, such as bright or dark points with a stable brightness that are visible on the image. Tube series scopes offer the possibility of removing any defective pixels on the sensor using software, as well as to cancel the deletion.</p> <ul style="list-style-type: none"> <li>● Press and hold the <b>Controller (4)</b> to enter the main menu.</li> <li>● Rotate the <b>Controller (4)</b> to select the <b>Pixel Defect Correction</b> option.</li> <li>● APress the <b>Controller (4)</b> briefly to enter the pixel defect correction interface.</li> </ul>

- A small cross cursor appears in the center of the screen instead of the reticle and the PIP function is automatically enabled, which is displayed in the lower left corner of the screen by default.
- The right side of the PIP window shows the options of moving direction (X-axis, Y-axis) and number of corrected pixels.
- Press the **Controller (4)** briefly to switch between the X-axis and the Y-axis. X-axis is selected by default.
- Rotate the **Controller (4)** to move along the direction selected. Rotate clockwise to move the cursor rightward / downward, and rotate anticlockwise to move the cursor leftward / upward.
- When the cursor moves to the position of the defect pixel, press the **Power button (5)** briefly to add and correct it. At the same time, the word **Add** flashes on the PIP window indicating that the pixel defect has been added.
- At the same position, press the **Power button (5)** briefly again to revoke the defect pixel correction and the word **Del** will flash on the PIP window.
- Repeat the above steps to complete the correction of other defect pixels.
- Each time you add or delete a pixel defect, the number of pixel defects changes accordingly.
- When the cursor moves near the PIP window, PIP and the content on the right move to the upper left corner automatically.





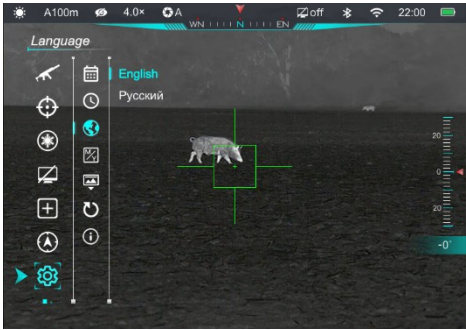

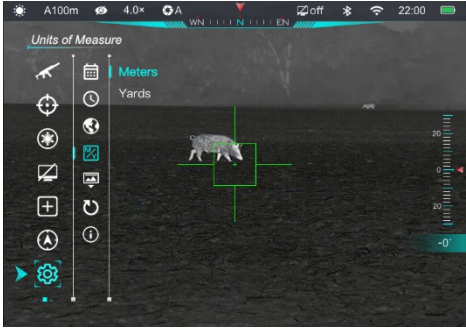
	<ul style="list-style-type: none"> <li>● After correction, press and hold the <b>Controller (4)</b> until a prompt <b>"Do you want to keep these settings?"</b> is displayed.</li> <li>● Rotate the <b>Controller (4)</b> to select <b>'Yes'</b> to save and exit, or select <b>'No'</b> to cancel saving and exit.</li> <li>● Press the <b>Controller (4)</b> briefly to confirm the selection.</li> <li>● When <b>Yes</b> is selected, a <b>5-second Saving</b> countdown appears on the screen. It will exit to the home screen after the prompt <b>Saving successful</b> appears.</li> </ul>	
<p style="text-align: center;"><b>Compass Calibration</b></p> 	<p><b>Calibrate the digital compass</b></p> <ul style="list-style-type: none"> <li>● Turn the <b>Controller (4)</b> to select <b>Compass Calibration</b> from the main menu.</li> <li>● Press the <b>Controller (4)</b> briefly to enter the <b>Compass Calibration</b> interface.</li> <li>● An icon like a triaxial coordinate system appears on the screen.</li> <li>● In the 15 seconds, rotate the scope along the three axes indicated by the icon, with each axis rotating at least 360°.</li> <li>● After 15s, the calibration is finished automatically and exit to the home screen.</li> </ul>	
<p style="text-align: center;"><b>Settings</b></p> 	<p>This function is used to set the date, time, language, measurement unit, status auto hiding, factory reset, and view the device information.</p> <ul style="list-style-type: none"> <li>● Press and hold the <b>Controller (4)</b> to enter the main menu.</li> <li>● Rotate the <b>Controller (4)</b> to select the <b>Settings</b> option.</li> <li>● Press the <b>Controller (4)</b> briefly to enter the submenu.</li> <li>● This menu item allows you to configure the following settings.</li> </ul>	

<p style="text-align: center;"><b>Date</b></p> 	<p><b>System Date Setting</b></p> <ul style="list-style-type: none"> <li>● Rotate the <b>Controller (4)</b> to select the <b>Date</b> option.</li> <li>● The date is displayed in the format of YYYY/MM/DD.</li> <li>● Press the <b>Controller (4)</b> briefly to activate the date reset function. Two small triangle symbols are displayed above and below the 'Year' in default.</li> <li>● Rotate the <b>Controller (4)</b> to set the desired year, month and date.</li> <li>● Press the <b>Controller (4)</b> briefly to switch between digits.</li> <li>● After setting, press and hold the <b>Controller (4)</b> to save changes and exit from the date reset function.</li> </ul>	
<p style="text-align: center;"><b>Time Setup</b></p> 	<p><b>System Time Setting</b></p> <ul style="list-style-type: none"> <li>● Rotate the <b>Controller (4)</b> to select the <b>Time</b> option.</li> <li>● The time is displayed in 24-hours format as HH: MM.</li> <li>● Press the <b>Controller (4)</b> briefly to activate the time reset function. Two small triangle symbols are displayed above and below the 'Hour' in default.</li> <li>● Rotate the <b>Controller (4)</b> to select the hour value.</li> <li>● Press the <b>Controller (4)</b> briefly to proceed the minute setting.</li> <li>● Rotate the <b>Controller (4)</b> to select the minute value.</li> </ul>	

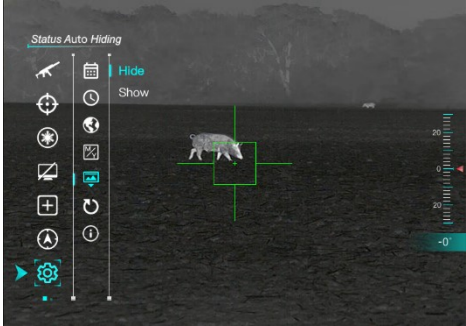
	<ul style="list-style-type: none"> <li>● After setting, press and hold the <b>Controller (4)</b> to save the selected time and exit from the time reset function.</li> <li>● When the time is reset, the icon on the status bar will be updated accordingly.</li> </ul>
<p style="text-align: center;"><b>Language</b></p> 	<p><b>Language Selection</b></p> <ul style="list-style-type: none"> <li>● Rotate the <b>Controller (4)</b> to select the <b>Language</b> option.</li> <li>● Press the <b>Controller (4)</b> briefly to enter the <b>Language</b> submenu.</li> <li>● Rotate the <b>Controller (4)</b> to switch the language between English and Russian.</li> <li>● Press the <b>Controller (4)</b> briefly to confirm the selection and exit from the submenu. The system language will change automatically.</li> </ul> 
<p style="text-align: center;"><b>Units of Measure</b></p> 	<p><b>Units of Measure Selection</b></p> <ul style="list-style-type: none"> <li>● Rotate the <b>Controller (4)</b> to select the <b>Units of Measure</b> option.</li> <li>● Press the <b>Controller (4)</b> briefly to enter the <b>Units of Measure</b> submenu.</li> <li>● Rotate the <b>Controller (4)</b> to select the unit of measure - meters or yards.</li> <li>● Press the <b>Controller (4)</b> briefly to confirm the selection and exit from the submenu.</li> </ul> 

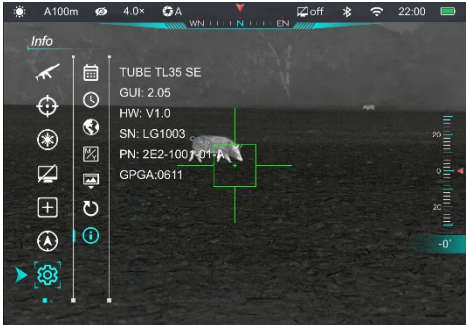

<p style="text-align: center;"><b>Status Auto Hiding</b></p> 	<p><b>Turn on / off the Status Auto Hiding function</b></p> <ul style="list-style-type: none"> <li>● Rotate the <b>Controller (4)</b> to select the <b>Status Auto Hiding</b> option.</li> <li>● Press the <b>Controller (4)</b> briefly to enter the <b>Status Auto Hiding</b> submenu.</li> <li>● Rotate the <b>Controller (4)</b> to select <b>Hide</b> or <b>Show</b>.</li> <li>● Press the <b>Controller (4)</b> briefly to confirm the selection and exit from the submenu.</li> <li>● When <b>Hide</b> is selected, all GUI icons without reticle will be automatically hidden if there is no operation within 8s.</li> </ul>	
<p style="text-align: center;"><b>Factory Reset</b></p> 	<p><b>Restore to the factory default settings</b></p> <ul style="list-style-type: none"> <li>● Rotate the <b>Controller (4)</b> to select the <b>Factory Reset</b> option.</li> <li>● Press the <b>Controller (4)</b> briefly to enter the <b>Factory Reset</b> submenu.</li> <li>● Rotate the <b>Controller (4)</b> to select <b>Yes</b> to restore factory default settings or <b>No</b> to cancel the operation.</li> <li>● Press the <b>Controller (4)</b> briefly to confirm the selection.</li> <li>● If <b>Yes</b> is selected, the scope will restart automatically.</li> <li>● If <b>No</b> is selected, the operation will be aborted and will exit from the submenu.</li> </ul> <p>The following functions will be restored to their default settings:</p>	

		<ul style="list-style-type: none"> <li>- <b>Image Mode:</b> White hot</li> <li>- <b>Zeroing Distance:</b> A100</li> <li>- <b>PIP:</b> Off</li> <li>- <b>Ultra-Clear Mode:</b> Off</li> <li>- <b>Wi-Fi:</b> Off</li> <li>- <b>Calibration Mode:</b> A</li> <li>- <b>Recoil Activated Video:</b> Off</li> <li>- <b>Compass and Motion Sensor:</b> Off</li> <li>- <b>Bluetooth:</b> Off</li> <li>- <b>Standby:</b> Off</li> <li>- <b>Language:</b> English</li> <li>- <b>Units of Measure:</b> Meter</li> <li>- <b>Status Auto Hiding:</b> Show</li> </ul>
	<p><b>Info</b></p> 	<p><b>Shown the device information</b></p> <ul style="list-style-type: none"> <li>● Rotate the <b>Controller (4)</b> to select the <b>Info</b> option.</li> <li>● Press the <b>Controller (4)</b> briefly to show the relevant information about the current scope, including the product model, GUI version, Hardware version, PN and SN number of the riflescope, FPGA.</li> <li>● Press and hold the <b>Controller (4)</b> to exit and return to the upper menu.</li> </ul> 

## 17 Status Auto Hiding

TUBE SE Series supports automatically hiding the GUI icons and showing the reticle only so that there is no blocking on the image.

- Press and hold the **Controller (4)** to enter the main menu on the home screen.
- Rotate the **Controller (4)** to select the **Settings** option.
- Press the **Controller (4)** briefly to enter the **Settings** submenu, and rotate the **Controller (4)** to select the **Status Auto Hiding** option.
- Press the **Controller (4)** briefly to enter the **Status Auto Hiding** submenu.
- Rotate the **Controller (4)** to select **Hide** or **Show**.
- Press the **Controller (4)** briefly to confirm the selection and exit from the submenu.
- When **Hide** is selected, all GUI icons including the status bar will be automatically hidden and only the reticle will be displayed on the image if there is no operation within 8s.
- The GUI icons will be displayed with the press of any button.
- Only after the GUI icons is displayed, the buttons and menus can

be manipulated.

## 18 Wi-Fi Function

TUBE SE Series has a built-in Wi-Fi module and can connect wirelessly to a mobile device (laptop or mobile phone) via Wi-Fi.

- On the main menu, turn on the Wi-Fi function (refer to **Main Menu - Wi-Fi** for details).
- After the Wi-Fi function is on, search for the Wi-Fi signal with the name "InfiRay-TUBE\_XXXXXX" on the mobile device, among which XXXXXX is a 6-bit serial number composed of letters and digits.
- Select the Wi-Fi and enter the password to connect. The initial password is 12345678.
- When Wi-Fi is successfully connected, it supports to control the scope via the **InfiRay Outdoor** App downloaded in the mobile device.

### Setting Wi-Fi Name and Password

The Wi-Fi name and password of the device can be reset on the **InfiRay Outdoor** App.

- After the scope is connected to the mobile device, and click the ‘Settings’ icon on the  InfiRay Outdoor image screen to enter the Settings interface.
- In the text box, enter and submit the new Wi-Fi name (SSID) and password.
- It needs to reboot the device to take the new name and password effect.

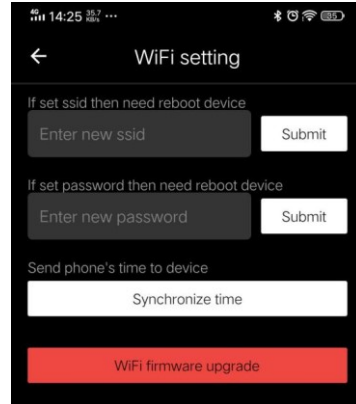

**Note:** If the device is reset to the factory settings, the name and password of the Wi-Fi will also be restored to the default settings.

## 19 Updates and InfiRay Outdoor

The TUBE SE Series Thermal Imaging Scope support **InfiRay Outdoor** technology, which allows you to transmit images to the smartphone or tablet via Wi-Fi in real time mode.

The user manual of InfiRay Outdoor can be downloaded at our official website ([www.infirayoutdoor.com](http://www.infirayoutdoor.com)).

Continuous improvements will be made to improve the user experience. The latest programs can be automatically detected and updated via the InfiRay Outdoor App. Also, it is feasible to download and update from the official website: [www.infirayoutdoor.com](http://www.infirayoutdoor.com).

### About InfiRay Outdoor

- You can download and install the InfiRay Outdoor App on the official website ([www.infirayoutdoor.com](http://www.infirayoutdoor.com)) or the app store. Alternatively, you can scan the QR code to download it for free.



- Open the InfiRay Outdoor App after installation.
- If your device has been connected to a mobile device, please turn on the mobile data of the mobile device. After connection, an update prompt will be displayed automatically on the App. Tap **Now** to download the latest version immediately or **Later** to update later.

- InfiRay Outdoor automatically registers the last connected device. Therefore, once you have connected with InfiRay Outdoor before, it will automatically detect the update even when the scope is not connected to the mobile device.
- If an update is available and the mobile device accesses the Internet, you can download the update first. Then when the device is connected with the mobile device, it will be updated automatically.
- After the update is installed, the device will restart automatically.

## 20 Technical Inspection

Perform a technical inspection to check the following items each time before you use the device.

- Exterior of the device (no crack on the enclosure).
- Lens and eyepiece (no crack, oil, stain, or other sediments).
- Status of the rechargeable battery (fully charged in advance) and electrical contact (no salinization or oxidation).

## 21 Maintenance

The maintenance should be carried out at least twice a year and includes the following steps:

- Wipe the surface of metal and plastic parts to clear off dust and dirt by using a cotton cloth. Silicone grease may be used for the cleaning process.
- Clean the electric contacts and battery slots on the device using a non-greasy organic solvent.
- Check the glass surface of the eyepiece and lens. If necessary, clear off the dust and sand on the lens (it is perfect to use a non-contact method). Use a specialized wiping tool and solvent to clean the optical surfaces.

## 22 Troubleshooting

The following table lists all problems that are likely to occur during device operation. Check and address problems by referring to this table. If faults not included in this table occur or you cannot fix the fault, return the

device to its vendor or supplier for troubleshooting.

Fault	Possible Causes	Solution
The scope cannot be started.	The battery is out of charge.	Charge
The device cannot be powered by using an external power supply.	The USB cable is damaged.	Replace the USB cable.
	The external power supply is insufficient.	If necessary, check the external power supply.
Images are unclear, vertical lines are present, or the background is not even.	Calibration is required.	Calibrate the images as instructed in Chapter XIV of the User Manual.
The image is too dark.	The screen is not bright enough.	Adjust the display brightness
The icons are clear but the image is blurry.	The lens is not focused.	Rotate the lens focus ring to adjust the focus.
	The inner or outer optical surface of the lens is dusted or iced.	Wipe the outer optical surface by using a soft cotton cloth or leave the scope to dry in a warm and dry environment for more than 4 hours.
The position of the reticle moves after shooting.	The scope or the clamp is not mounted firmly.	<p>Check whether the scope is mounted firmly.</p> <p>Ensure that the bullet type and caliber you use are consistent with that used for zeroing.</p> <p>If you have performed zeroing in summer but are using the scope in winter (or vice versa), the zeroing point may have changed slightly.</p>
The scope cannot focus.	Configuration error.	Set the scope according to Section VII Mounting and Usage.

		<p>Check the outer surface of the objective lens and eyepiece, and if necessary, wipe off any dust and frost on it.</p> <p>In cold weather, a special antifogging coating can be applied (such as those used on eyeglasses or car rearview mirrors).</p>
The device cannot connect to a mobile phone or computer.	The Wi-Fi password is incorrect.	Enter the correct password.
	There are too many Wi-Fi networks in the range of the device, which may cause interference.	To enable stable network access, you are advised to move the device to an area with a limited number of Wi-Fi networks, or an area without Wi-Fi coverage.
Wi-Fi signals are lost or interrupted.	<p>The device is beyond Wi-Fi coverage.</p> <p>There is blocking (such as concrete walls) between the device and the receiver.</p>	Move the device to a place where you can receive Wi-Fi signals.
The observed target disappears.	You are observing the target through the glass.	Observe the target directly without the presence of glass.
The image quality is poor or the detection range shortens.	These problems are likely to occur when you use the device in harsh weather (such as snow, rain, fog).	
When the device is used at a low temperature, the imaging quality is poorer than that at a normal temperature.	At temperatures above 0°C, the temperature rise varies with the observed objects (environment and background) due to different heat conductivity coefficients. As a result, high-temperature contrast occurs and the image quality is better.	
	At low temperatures, the observed targets (background) usually cool down to a similar temperature	

because of reduced temperature contrast. Therefore, the image quality (details in particular) is poor, which is a characteristic of thermal imaging devices.

## 23 Legal and Regulatory Information

Wireless transmitter module frequency range:

**WLAN: 2.400-2.500GHz (for EU)**

Wireless transmitter module power < 20dBm (only for EU)

 IRay Technology Co., Ltd. thus declares that the Tube SE Series complies with the directives 2014/53/EU and 2011/65/EU. The full text of the EU declaration of conformity as well as additional information are available at: [www.infirayoutdoor.com](http://www.infirayoutdoor.com).

This device may be operated in all member states of the EU.

### FCC Statement

**FCC ID: 2AYGT-2D00**

### Labeling requirements

This device complies with part 15 of the FCC Rules. Operation is subject to the following two conditions: (1) This device may not cause harmful interference, and (2) this device must accept any interference received, including interference that may cause undesired operation.

### Information to the user

Any Changes or modifications not expressly approved by the party responsible for compliance could void the user's authority to operate the equipment.

**Note:** The manufacturer is not responsible for any radio or TV interference caused by unauthorized modifications to this equipment. Such modifications could void the user's authority to operate the equipment.

**Note:** This equipment has been tested and found to comply with the limits for a Class B digital device, pursuant to part 15 of the FCC Rules.



These limits are designed to provide reasonable protection against harmful interference in a residential installation. This equipment generates uses and can radiate radio frequency energy and, if not installed and used in accordance with the instructions, may cause harmful interference to radio communications. However, there is no guarantee that interference will not occur in a particular installation. If this equipment does cause harmful interference to radio or television reception, which can be determined by turning the equipment off and on, the user is encouraged to try to correct the interference by one or more of the following measures:

- Reorient or relocate the receiving antenna.
- Increase the separation between the equipment and receiver.
- Connect the equipment into an outlet on a circuit different from that to which the receiver is connected.
- Consult the dealer or an experienced radio/TV technician for help.

This equipment complies with FCC RF radiation exposure limits set forth for an uncontrolled environment.

### **Body-worn Operation**

This device was tested for typical body-support operations. To comply with RF exposure requirements, a minimum separation distance of 0.5cm must be maintained between the user's body and the handset, including the antenna. Third-party belt-clips, holsters, and similar accessories used by this device should not contain any metallic components. Body accessories that do not meet these requirements may not comply with RF exposure requirements and should be avoided. Use only the supplied or an approved antenna.